

# MEMS-FPI spectrum sensor

## Contents

1. Overview .....	1
2. Structure .....	1
2-1 MEMS-FPI tunable filter .....	2
3. Characteristics .....	2
3-1 Absolute maximum ratings.....	2
3-2 Filter control voltage and peak transmission wavelength.....	3
3-3 Spectral resolution .....	10
3-4 Spectral transmittance of the band-pass filter .....	11
3-5 Pull-in phenomenon .....	13
3-6 Temperature characteristics .....	16
3-7 Thermistor characteristics.....	24
3-8 Transmittance of MEMS-FPI tunable filter .....	26
3-9 Incident light aperture angle.....	27
3-10 InGaAs PIN photodiodes .....	30
4. How to use.....	31
4-1 Connection example.....	31
4-2 Evaluation circuit .....	31
4-3 Example of evaluation system .....	32
4-4 Applications.....	33
5. Q&A.....	34

## 1. Overview

The MEMS-FPI spectrum sensor is an ultra-compact sensor that houses a MEMS-FPI (Fabry-Perot Interferometer) tunable filter that can vary its transmission wavelength depending on the applied voltage and InGaAs PIN photodiode in a single package. The spectral response range covers the infrared region. It is suitable for installation in compact devices for identifying materials in plastic and solutions, detecting moisture, analyzing ingredients in agricultural products and food, and other similar applications.

## 2. Structure

The MEMS-FPI spectrum sensor is composed of a MEMS-FPI tunable filter, photosensor (photodiode), and the like. It has a simple structure in which a MEMS-FPI tunable filter and photosensor is arranged on the same axis as the direction of the incident light. Though this product is a spectral sensor, it uses a single photosensor device and does not require an expensive multichannel photosensor.

[Figure 2-1] Internal structure

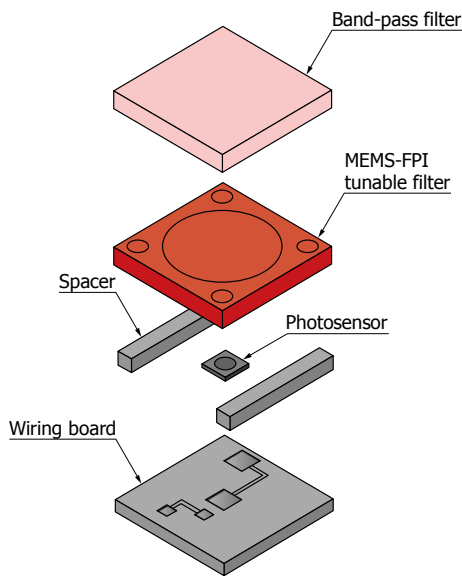

KIRDC0108EC

## 2-1 MEMS-FPI tunable filter

The MEMS-FPI tunable filter has an upper mirror and a lower mirror that are placed opposite each other with an air gap in between them [Figure 2-2]. When a voltage is applied across the mirrors, an electrostatic force is produced to adjust the air gap. To facilitate this action, the upper mirror has a membrane (thin film) structure. If the air gap is  $m\lambda/2$  ( $m$ : integer), it functions as a filter that allows by and large wavelength  $\lambda$  to pass through. Increasing the filter control voltage shortens the air gap by electrostatic force, causing the peak transmission wavelength to shift to the shorter wavelength side.

Silicon is used as the substrate that serves as an infrared-transmitting filter. The mirrors are designed as multilayered dielectric coatings of  $\text{SiO}_2$ ,  $\text{SiN}$  or Poly-Si, which are typical semiconductor materials. .

[Figure 2-2] Cross-sectional view of MEMS-FPI tunable filter

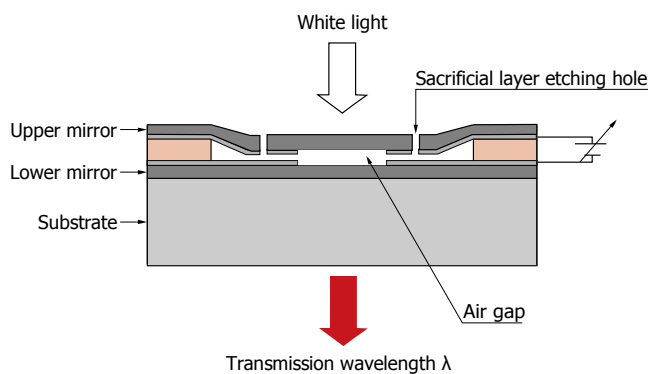

KIRDB0109EA

## 3. Characteristics

### 3-1 Absolute maximum ratings

Exceeding the absolute maximum ratings even momentarily may cause a drop in product quality. Always be sure to use the product within the absolute maximum ratings. The details about filter control voltage are described in section 5. Q&A, [Q3](#).

Note: The MEMS-FPI spectrum sensor is an electrostatic sensitive device. When handling the product, precautions need to be taken to avoid damage and deterioration due to static electricity. For details, refer to the instruction

manual supplied with the product.

### 3-2 Filter control voltage and peak transmission wavelength

The MEMS-FPI spectrum sensor can vary its peak transmission wavelength based on the filter control voltage, but their relationship is not linear [Figure 3-1].

[Figure 3-1] Peak transmission wavelength vs. filter control voltage (typical example)

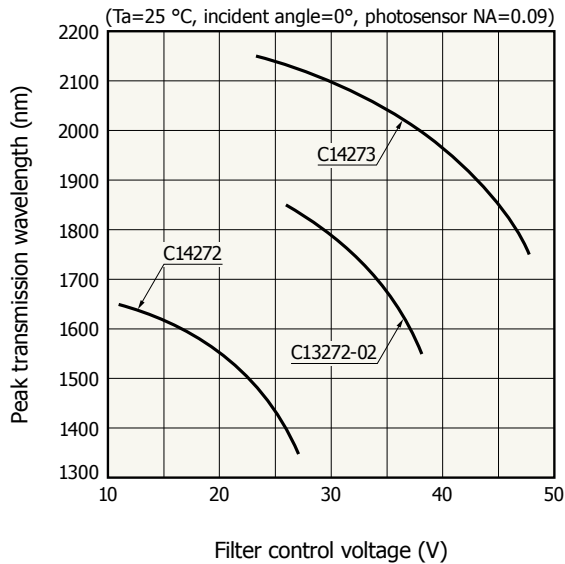

KACCB0482EB

Constants (sensor calibration coefficient) should be estimated by fitting the relation between filter control voltage and peak transmission wavelength with a polynomial. The relationship between filter control voltage and peak transmission wavelength can be expressed by the polynomial below.

The peak transmission wavelength of the MEMS-FPI spectrum sensor has temperature characteristics. For example, if the filter control voltage is tuned to a peak transmission wavelength of 1550 nm at 25 °C on C13272-02, and the temperature goes up to 45 °C in this state, the peak transmission wavelength is to be shifted to 1562 nm (about 12 nm wavelength shift from 1550 nm). The relationship between the filter control voltage and the peak transmission wavelength is expressed by the method using the room temperature compensation constant and the method using the temperature compensation constant.

#### At room temperature

The relationship between the filter control voltage and the peak transmission wavelength is expressed by the equation (3-1) when the temperature of the MEMS-FPI spectrum sensor can be kept at room temperature (25 °C).

$$V^2 = a_0 \lambda p^5 + b_0 \lambda p^4 + c_0 \lambda p^3 + d_0 \lambda p^2 + e_0 \lambda p + f_0 \cdots (3-1)$$

V: filter control voltage

$\lambda p$ : peak transmission wavelength [m]

You can calculate constants  $a_0$ ,  $b_0$ ,  $c_0$ ,  $d_0$ ,  $e_0$ ,  $f_0$  by using equations (3-2) to (3-12) using the room temperature compensation constants  $a$ ,  $b$ ,  $c$ ,  $g$  in the reference datasheet and the fixed value  $A$  for each type no. of the product.

Note:

- The filter control voltage calculated by equation (3-1) is reference data. There is no guarantee.
- $a$ ,  $b$ ,  $c$ ,  $g$  (conditions: Ta=25 °C, spectral response range) are different for each product.

$$C14272: Z = 1.5 \times 10^6 (1 - A), C13272-02: Z = 1.7 \times 10^6 (1 - A), C14273: Z = 1.95 \times 10^6 (1 - A) \cdots (3-2)$$

$$B_0 = -a \cdots(3-3)$$

$$C_0 = 3ag + b \cdots(3-4)$$

$$D_0 = -3ag^2 - 2bg - c \cdots(3-5)$$

$$E_0 = ag^3 + bg^2 + cg \cdots(3-6)$$

$$a_n = A^5 B_n \cdots(3-7)$$

$$b_n = A^4 (5B_n Z + C_n) \cdots(3-8)$$

$$c_n = A^3 (10B_n Z^2 + 4C_n Z + D_n) \cdots(3-9)$$

$$d_n = A^2 (10B_n Z^3 + 6C_n Z^2 + 3D_n Z + E_n) \cdots(3-10)$$

$$e_n = AZ (5B_n Z^3 + 4C_n Z^2 + 3D_n Z + 2E_n) \cdots(3-11)$$

$$f_n = Z^2 (B_n Z^3 + C_n Z^2 + D_n Z + E_n) \cdots(3-12)$$

C14272: A=1/0.755121951

C13272-02: A=1/0.753902939

C14273: A=1/0.751250854

We can calculate  $a_0, b_0, c_0, d_0, e_0, f_0$  by substituting  $n=0$  to equations (3-7) through (3-12). Substituting these values into equation (3-1) gives the filter control voltage corresponding to the peak transmission wavelength. Figure 3-2 shows measurement examples of the deviation between the peak transmission wavelength measured at 25 ° C by applying a specific filter control voltage and the peak transmission wavelength calculated by the equation of this method. The deviation is within  $\pm 0.5$  nm.

[Figure 3-2] Peak transmission wavelength precision  
(measurement example using room temperature compensation constant)  
(a) C14272 (number of samples: 409)

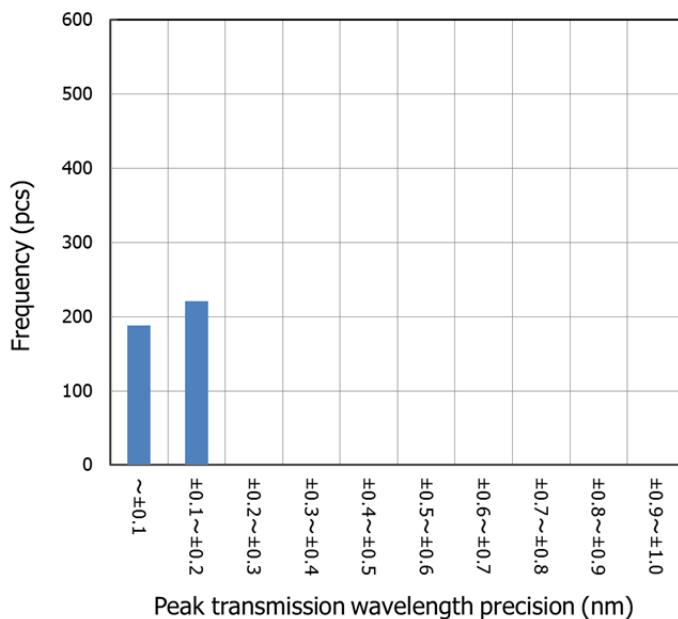

(b) C13272-02 (number of samples: 952)

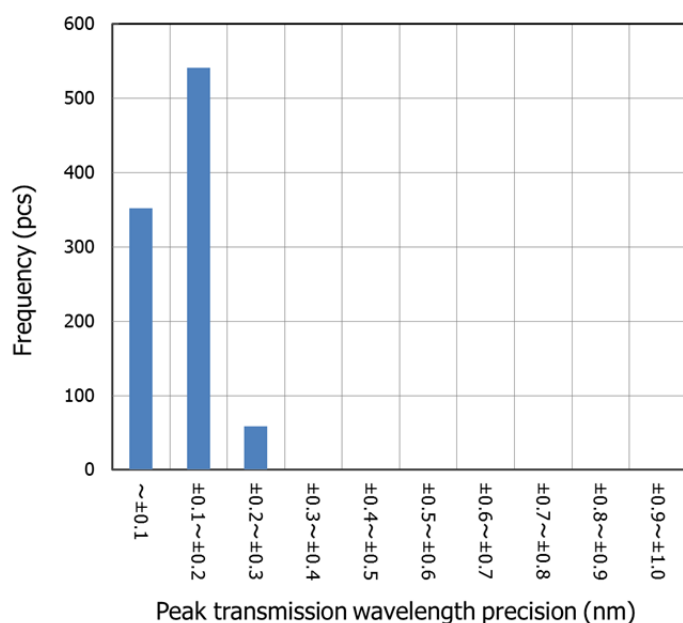

(c) C14273 (number of samples: 625)

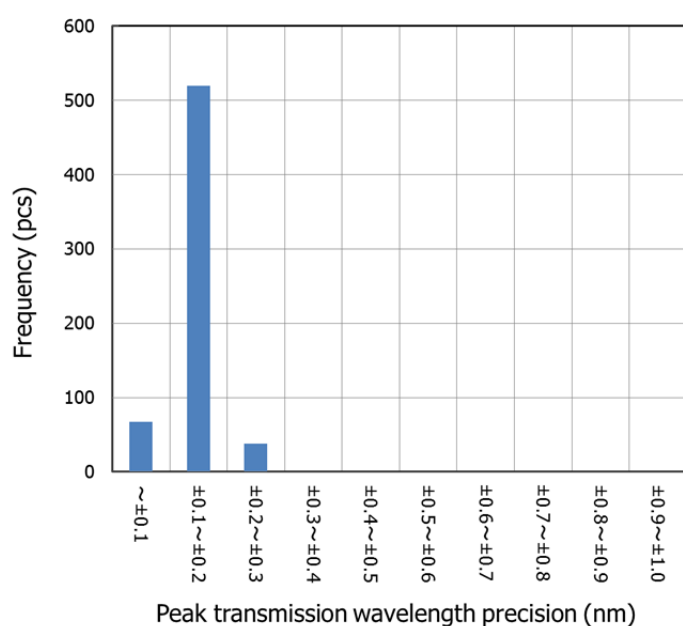

**Compensation of temperature characteristics' differences of filter control voltage and peak transmission wavelength**

This section explains how to compensate the change in peak transmission wavelength due to temperature change to several nm or less by using equations. The relationship between the filter control voltage and the peak transmission wavelength is expressed by equation (3-17). The calculation is done by adding the temperature change to equation (3-1) at room temperature.

$$B_1 = -p, B_2 = -t \cdots (3-13)$$

$$C_1 = 3pg + q, C_2 = 3tg + u \cdots (3-14)$$

$$D_1 = -3pg^2 - 2qg - r, D_2 = -3tg^2 - 2ug - v \cdots (3-15)$$

$$E_1 = pg^3 + qg^2 + rg + s, E_2 = tg^3 + ug^2 + vg + w \cdots (3-16)$$

p, q, r, s, t, u, v, w: temperature correction constant in the reference datasheet

$$V^2 = a_0\lambda p^5 + b_0\lambda p^4 + c_0\lambda p^3 + d_0\lambda p^2 + e_0\lambda p + f_0 + (a_1\lambda p^5 + b_1\lambda p^4 + c_1\lambda p^3 + d_1\lambda p^2 + e_1\lambda p + f_1) \Delta T + (a_2\lambda p^5 + b_2\lambda p^4 + c_2\lambda p^3 + d_2\lambda p^2 + e_2\lambda p + f_2) \Delta T^2 \dots (3-17)$$

V: filter control voltage

$\lambda p$ : peak transmission wavelength [m]

$\Delta T$ : temperature change for 25 ° C (T - 25 ° C)

" $a_0, b_0, c_0, d_0, e_0, f_0$ " " $a_1, b_1, c_1, d_1, e_1, f_1$ " " $a_2, b_2, c_2, d_2, e_2, f_2$ ": Each constant is derived from equations (3-7) (3-8) (3-9) (3-10) (3-11) (3-12).

Since it takes a long time to measure the temperature characteristics of all samples, we recommend that you correct temperature by using the temperature compensation constant shown in the reference datasheet for products with similar characteristics, such as the same lot. Figure 3-3 shows measurement examples of the deviation between the measured peak transmission wavelength and the peak transmission wavelength calculated using the temperature compensation constants.

The above temperature compensation constants were obtained under Hamamatsu 's evaluation conditions. The constants cannot be guaranteed under your conditions of use.

[Figure 3-3] Peak transmission wavelength precision  
(measurement example using temperature compensation constant)  
(a) C14272 (+5 to +45 °C: deviation=within ±0.6 nm, number of samples: 22)

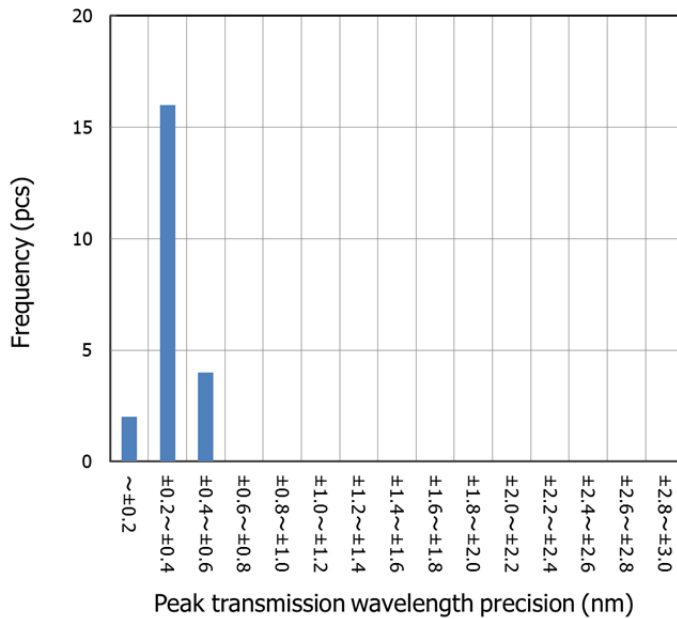

(b) C14272 (-20 to +85 °C: deviation=within  $\pm 1.6$  nm, number of samples: 22)

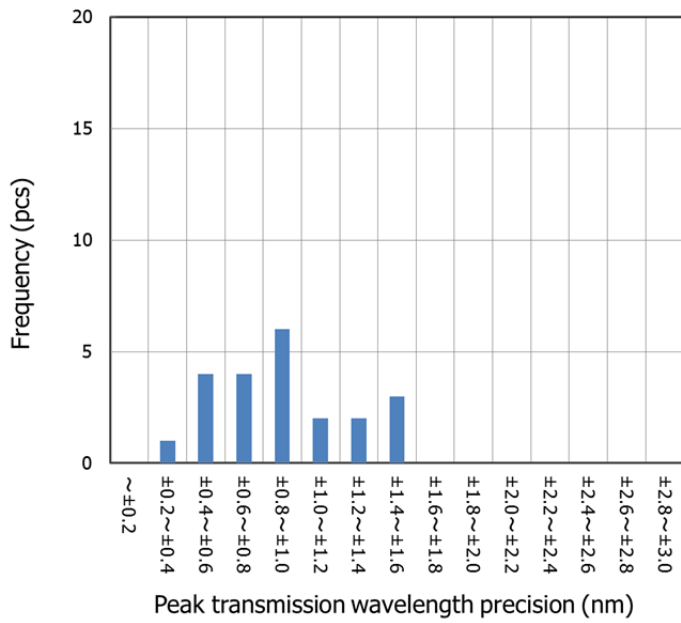

(c) C13272-02 (+5 to +45 °C: deviation=within  $\pm 0.6$  nm, number of samples: 20)

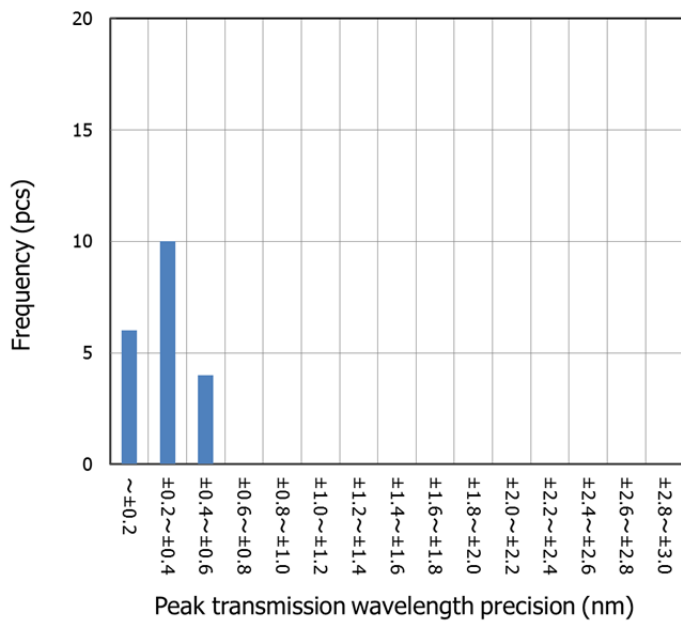

(d) C13272-02 (-20 to +85 °C: deviation=within  $\pm 1.2$  nm, number of samples: 20)

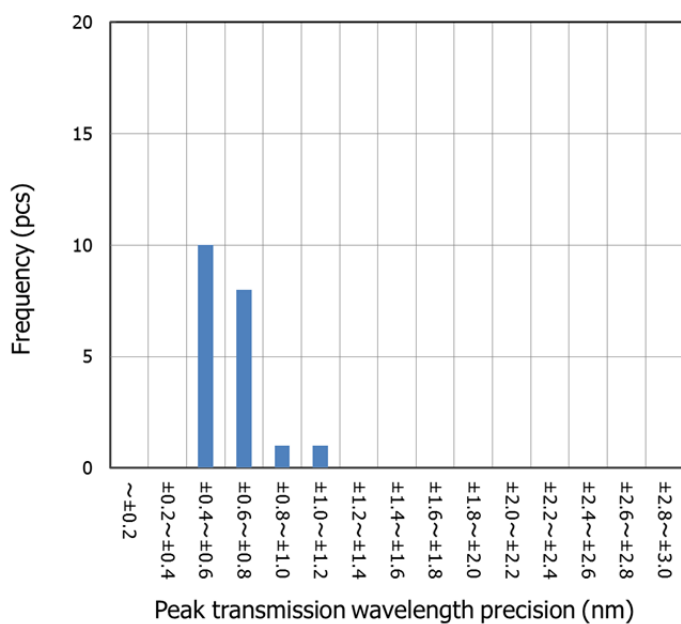

(e) C14273 (+5 to +45 °C: deviation=within  $\pm 0.8$  nm, number of samples:24)

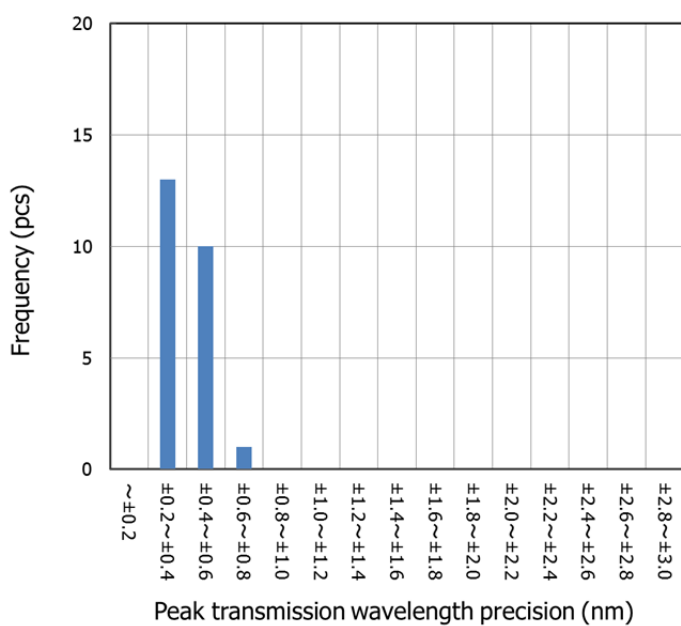



(f) C14273 (-20~+85 °C: deviation=within ±1.8 nm, number of samples: 24)

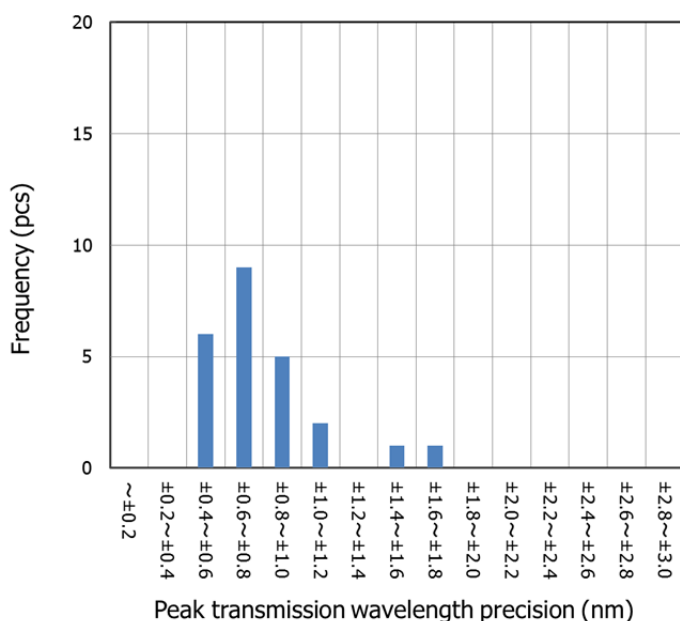

**When using evaluation circuit C13294-02**

When using Hamamatsu evaluation circuit C13294-02 for MEMS-FPI spectrum sensor, the calculated constants (sensor calibration coefficient) are used by fitting the relationship between the filter control voltage and the peak transmission wavelength with a 7th order polynomial. This polynomial allows the peak transmission wavelength to be calculated from the filter control voltage. Note that the C13294-02 does not support temperature compensation.

• Fitting example

Fitting is to be done by 7th order polynomial [equation (3-1)].

$$\lambda = a_0 + a_1 \cdot V + a_2 \cdot V^2 + a_3 \cdot V^3 + a_4 \cdot V^4 + a_5 \cdot V^5 + a_6 \cdot V^6 + a_7 \cdot V^7 \dots(3-1)$$

λ: peak transmission wavelength

V: filter control voltage

8 or more points of filter control voltage and peak transmission wavelength are needed to measure for estimating the constants a<sub>0</sub> to a<sub>7</sub>. A difference between a measurement value of peak transmission wavelength and its approximate value can be reduced by setting the filter control voltage at an equal interval.

As a typical example, fitting using the C13272-02 is shown in Table 3-1. The constants used for Table 3-1 fitting are shown in Table 3-2.

Note: The constants a<sub>0</sub> to a<sub>7</sub> are eigenvalues of an individual product, and these values are valid for the spectral response range only. Values calculated by equation (3-1) are just for reference, and not for guarantee. Constants a<sub>0</sub> through a<sub>7</sub> are stored for each serial number in the supplied CD-R. This is a text format that can be read by the software that comes with the evaluation kit C13294-02 (sold separately) for MEMS-FPI spectrum sensor.

[Table 3-1] Typical example of fitting (C13272-02)

	Measurement value	Approximate value	Approximate value - Measurement value
22.0	1892.4	1892.4	0.00
24.0	1873.1	1873.1	-0.01
26.0	1849.7	1849.8	0.04
28.0	1822.5	1822.4	-0.05
30.0	1790.7	1790.7	0.01
32.0	1752.5	1752.6	0.06
34.0	1705.7	1705.6	-0.08
36.0	1645.7	1645.7	0.03
37.0	1607.7	1607.8	0.07
38.0	1560.9	1560.8	-0.18
38.3	1544.0	1544.2	0.12

[Table 3-2] Constants used in fitting (Table 3-1) (sensor calibration coefficient, C13272-02, typical example)

$a_0$	$9.32970688702291 \times 10^4$
$a_1$	$-2.27370182059617 \times 10^4$
$a_2$	$2.41116075642313 \times 10^3$
$a_3$	$-1.41227604475764 \times 10^2$
$a_4$	$4.93485461095617 \times 10^0$
$a_5$	$-1.02915632281714 \times 10^{-1}$
$a_6$	$1.18655280570192 \times 10^{-3}$
$a_7$	$-5.83788694189641 \times 10^{-6}$

When a calculation is performed by substituting the constants of Table 3-2 into equation (3-1), the relationship between the peak transmission wavelength and filter control voltage become equivalent to that shown in Figure 3-1.

### 3-3 Spectral resolution

The spectral resolution of the MEMS-FPI spectrum sensor is defined based on the full width at half maximum of the spectrum [Figure 3-2]. It is defined as the spectrum span at the 50% level of the spectrum peak value. Figure 3-5 shows a measurement example of the spectral resolution of a MEMS-FPI spectrum sensor.

[Figure 3-4] Definition of full width at half maximum

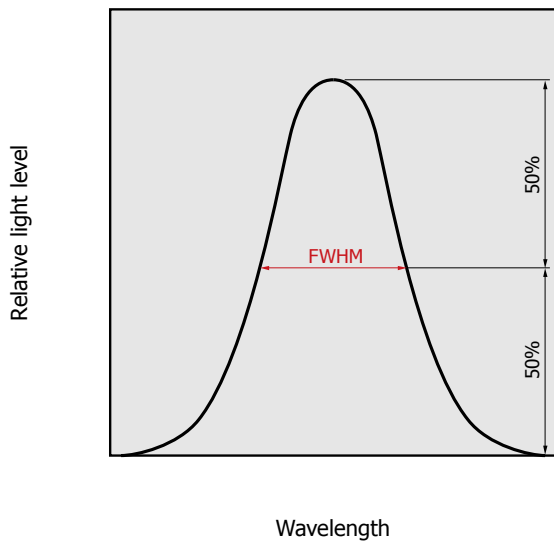

KACCC0320EB

[Figure 3-5] Spectral resolution vs. peak transmission wavelength (typical example)

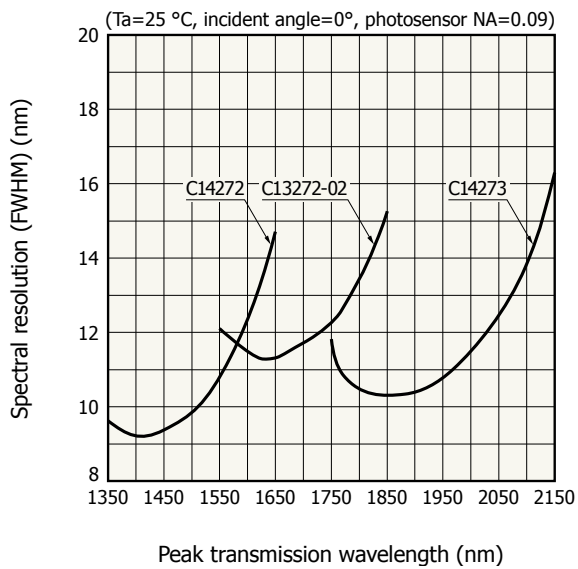

KACCB0483EB

### 3-4 Spectral transmittance of the band-pass filter

The MEMS-FPI spectrum sensor has a built-in band-pass filter for cutting off wavelengths outside the spectral response range. Figure 3-6 shows the spectral transmittance characteristics of the band-pass filter.

[Figure 3-6] Spectral transmittance characteristics of built-in band-pass filter (typical example)  
(a) C14272

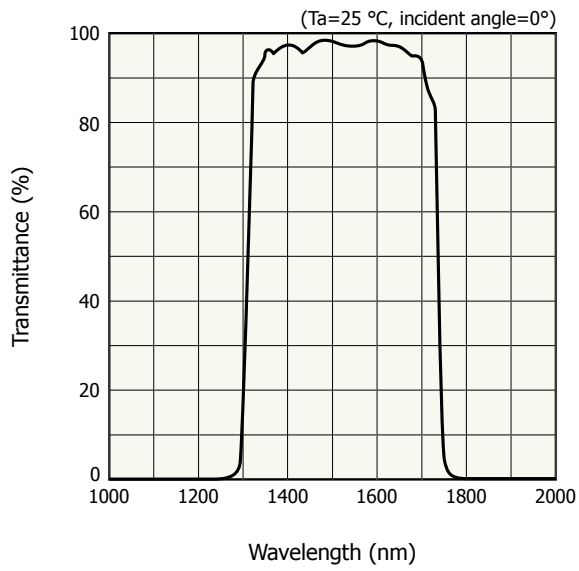

KACCB0476EB

(b) C13272-02

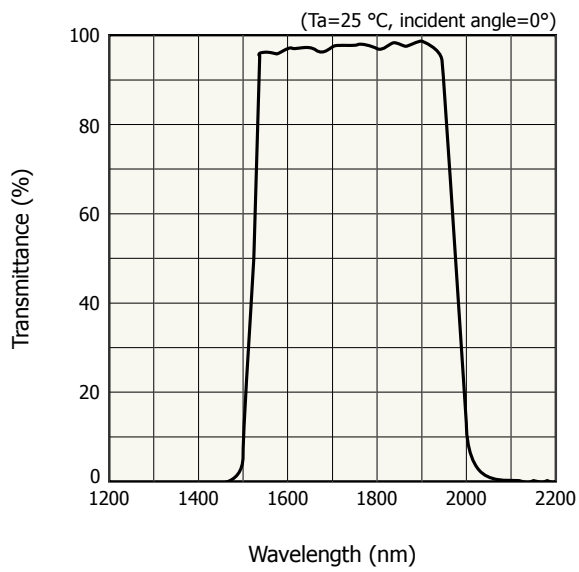

KACCB0433EB

(c) C14273

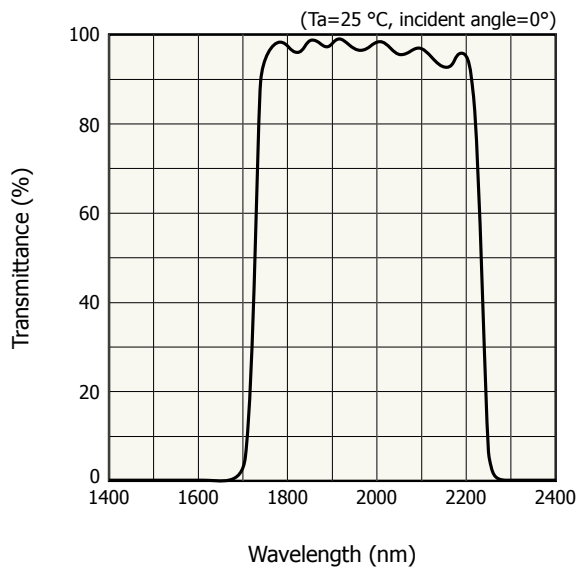

KACCB00507EA

### 3-5 Pull-in phenomenon

When operating a MEMS-FPI tunable filter, the so-called pull-in phenomenon should be taken into account. The pull-in phenomenon occurs when the balance between the electrostatic attractive force pulling the mirrors together by an electric field and the force of the springs on the upper mirror is thrown off. Normally, when these forces are in balance, the position of the upper mirror of the MEMS-FPI tunable filter is set, and the wavelength matching the air gap can be transmitted. However, if the filter control voltage increases to a given voltage, the electrostatic attractive force becomes stronger than the force of the springs. This causes the balance of forces to be thrown off, and the upper mirror sticks to the lower mirror. This is the pull-in phenomenon. If the upper mirror sticks to the lower mirror, it cannot be easily separated. To avoid this, the filter control voltage must be carefully adjusted when operating the MEMS-FPI tunable filter. The air gap at which a pull-in phenomenon occurs is about  $2/3$  of the initial air gap.

A relation between filter control voltage and peak transmission wavelength of the MEMS-FPI tunable filter is shown in Figure 3-7. The pull-in phenomenon should occur when an air gap becomes about  $2/3$  of an initial state at 0 V in the filter control voltage, and peak transmission wavelengths should be shifted sharply (broken line part). High accuracy of the filter control voltage is important, and due attention should be paid on an operation condition close to the pull-in phenomenon occurrence. The filter control voltage causing the pull-in phenomenon differs from unit to unit, which should be noted.

Furthermore, the pull-in phenomenon does not occur at the filter control voltage's absolute maximum rating or below, so the filter control voltage has to be set at a lower value than that of the absolute maximum rating.

[Figure 3-5] Pull-in phenomenon (broken line part)  
(a) C14272

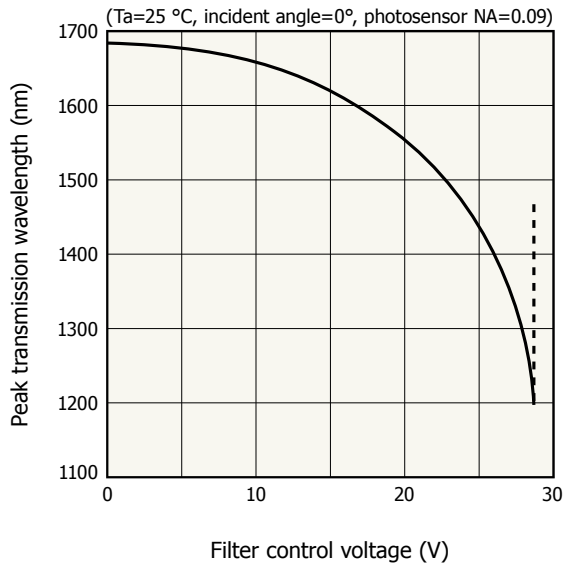

KACCB0484EA

(b) C13272-02

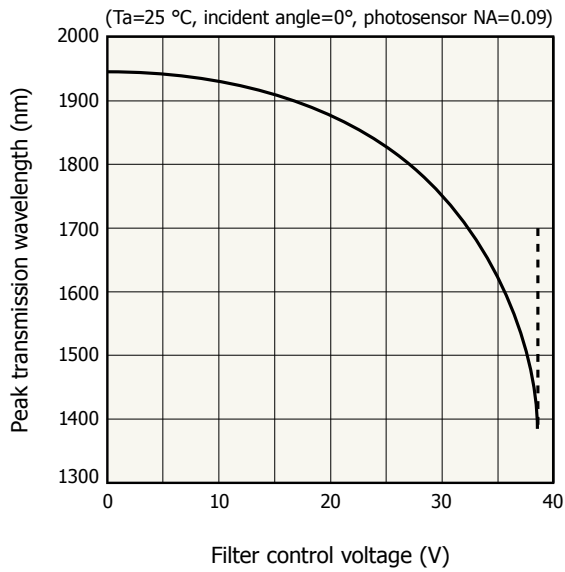

KACCB0442EA

(c) C14273

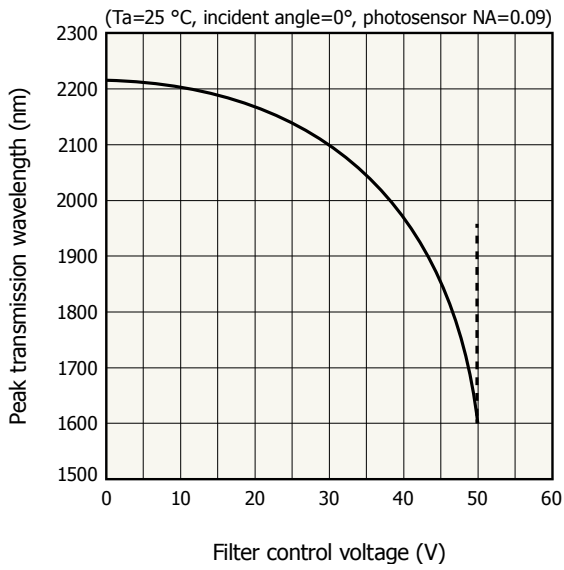

KACCB0518EB

A voltage value where the pull-in phenomenon occurs changes with temperature, which should be noted. A temperature characteristic of the pull-in phenomenon is shown in Figure 3-8.

[Figure 3-8] Temperature dependence of pull-in phenomenon (typical example)

(a) C14272

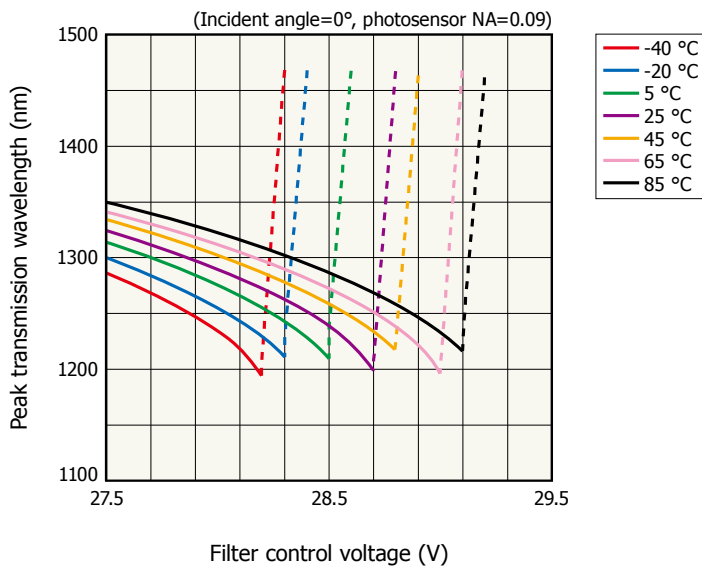

KACCB0485EA

(b) C13272-02

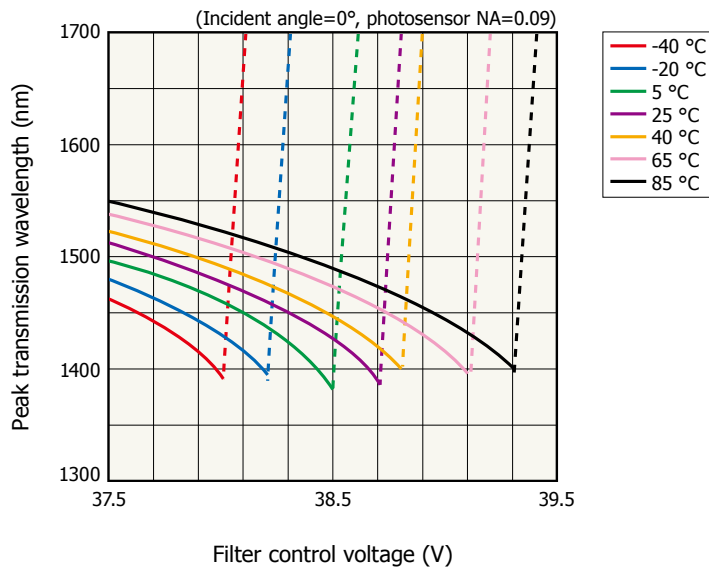

KACCB0443EA

(c) C14273

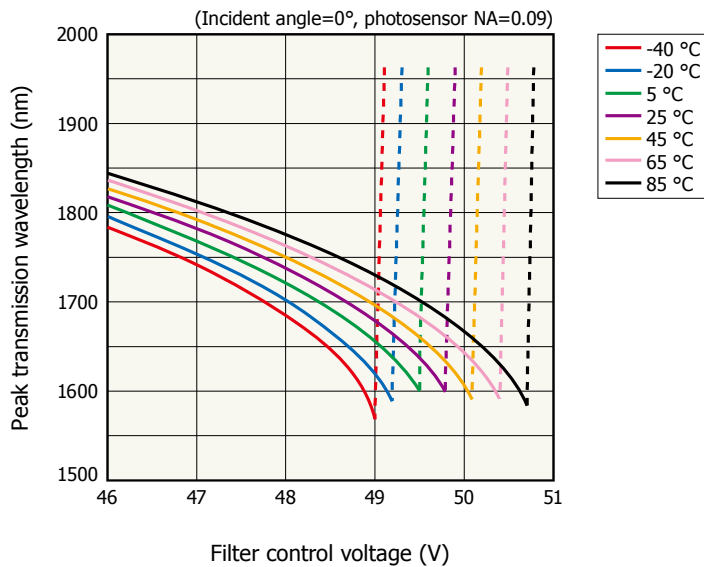

KACCB0519EA

### 3-6 Temperature characteristics

A peak transmission wavelength of a MEMS-FPI spectrum sensor has temperature dependence.

- C14272: 0.3 nm/°C typ. ( $\lambda=1500$  nm)
- C13272-02: 0.4 nm/°C typ. ( $\lambda=1700$  nm)
- C14273: 0.3 nm/°C typ. ( $\lambda=1950$  nm)

A relation between peak transmission wavelength and ambient temperature at filter control voltage kept constant is shown in Figure 3-9.



[Figure 3-9] Peak transmission wavelength vs. ambient temperature (typical example)  
 (a) C14272

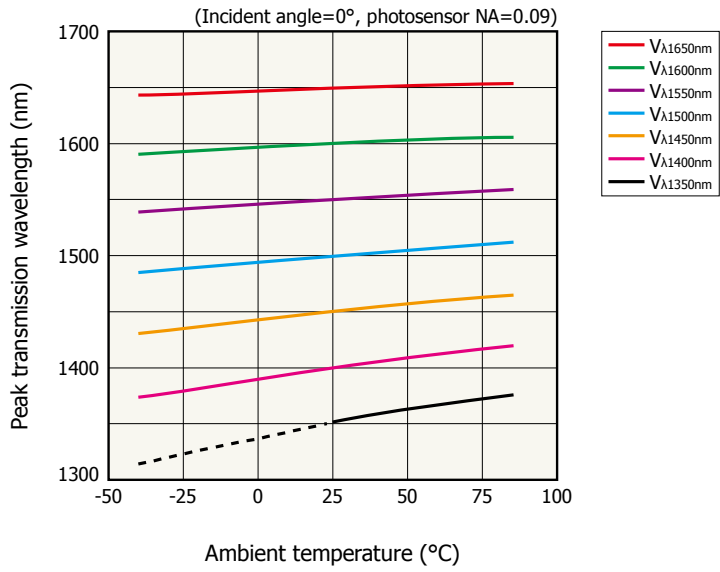

(b) C13272-02

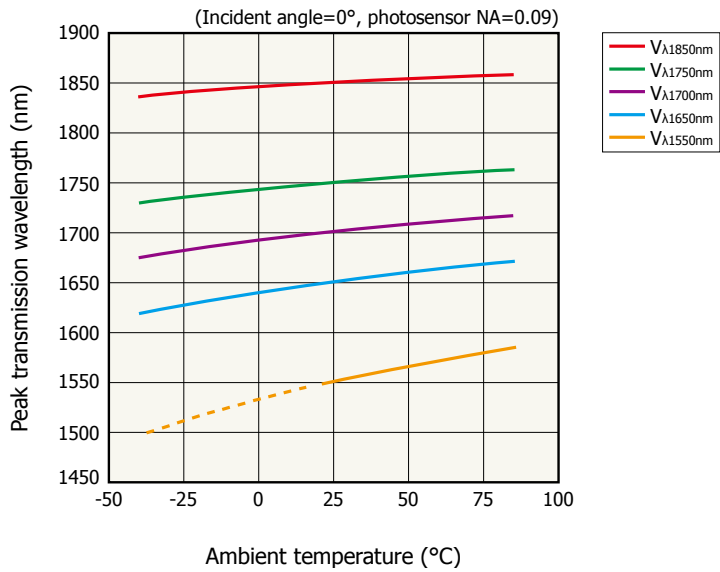

(c) C14273

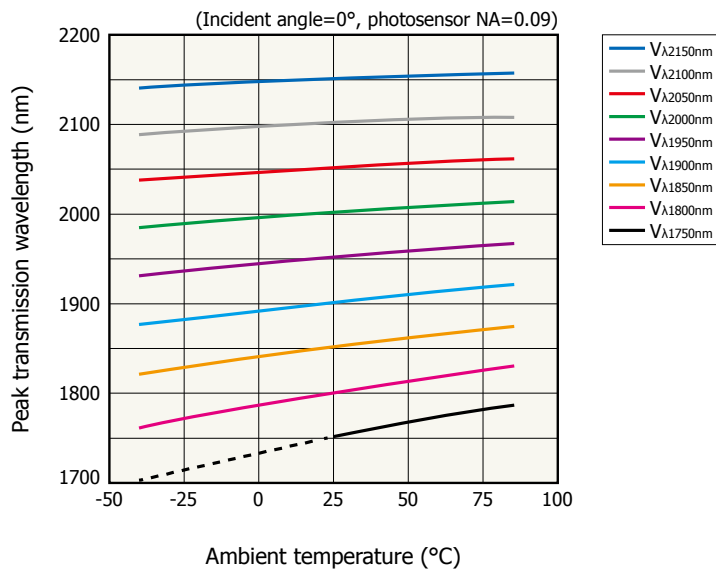

KACCB0505EA

Furthermore, peak transmission wavelength shifts at the temperature changes [low temperature side (-40→+25 °C) and high temperature side (+25→+85 °C)] are shown in Figure 3-10, where the estimation is done by using Figure 3-9 data. A wavelength shift becomes greater at a shorter peak transmission wavelength, and also that at a low temperature side is greater than that at a high temperature side. The broken line range of Figure 3-9 and Figure 3-10 corresponds to data when the built-in band-pass filter is removed.

The peak transmission wavelength cannot be detected accurately in the broken line range of Figure 3-9 and Figure 3-10. This is because when the ambient temperature is less than 25 °C, the peak transmission wavelength of the MEMS-FPI tunable filter is outside the transmission wavelength range of the band-pass filter.

[Figure 3-10] Peak transmission wavelength shift vs. peak transmission wavelength (typical example)  
(a) C14272

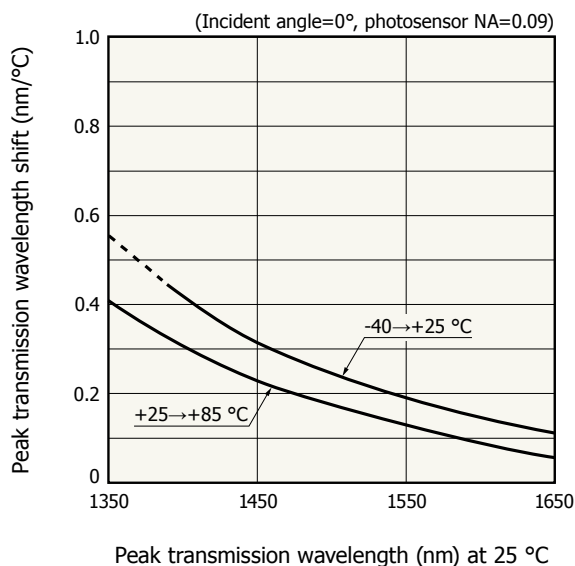

KACCB0486EA

(b) C13272-02

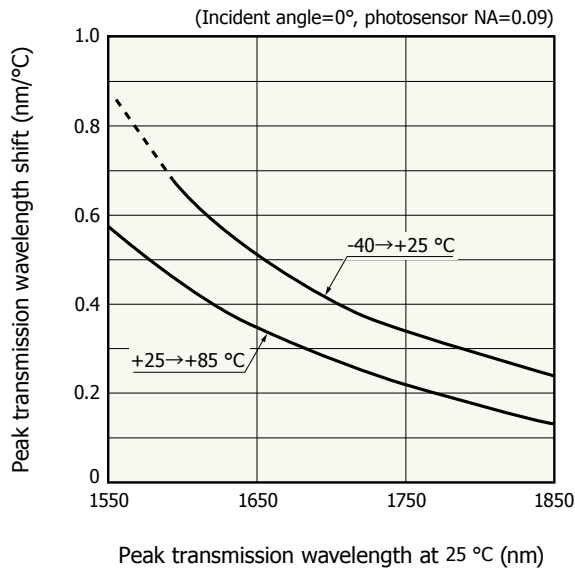

KACCB0444EA

(c) C14273

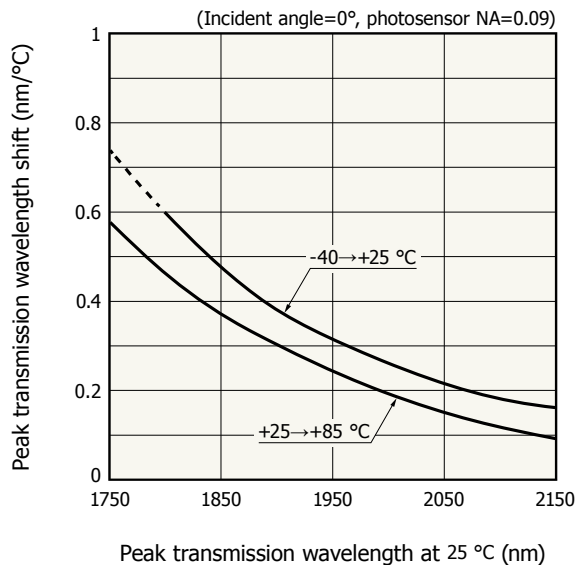

KACCB0520EA

Temperature characteristics of wavelength profile at the MEMS-FPI spectrum sensor's filter control voltage kept constant is shown in Figure 3-9.

Transmittance of a band-pass filter built in the sensors is inserted (transmittance of band-pass filter is hardly dependent on temperature). A wavelength profile is shifted to a shorter side by having ambient temperature be lower. A peak transmission wavelength becomes hard to detect with high accuracy at 25 °C or lower because the wavelength profile is in a region of low transmittance of the band-pass filter.

[Figure 3-11] Temperature characteristics of wavelength profile (typical example)  
 (a) C14272

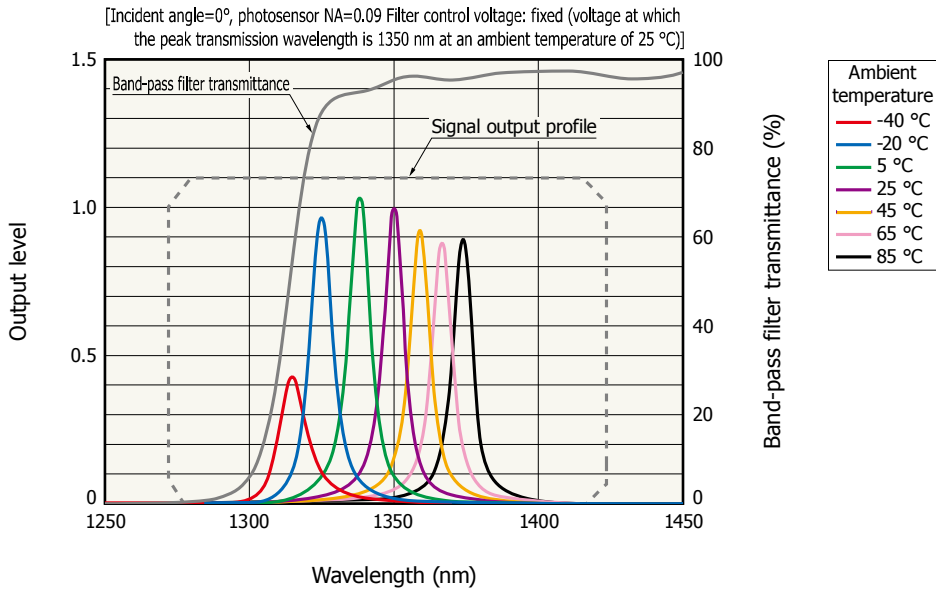

KACCB0487EA

(b) C13272-02

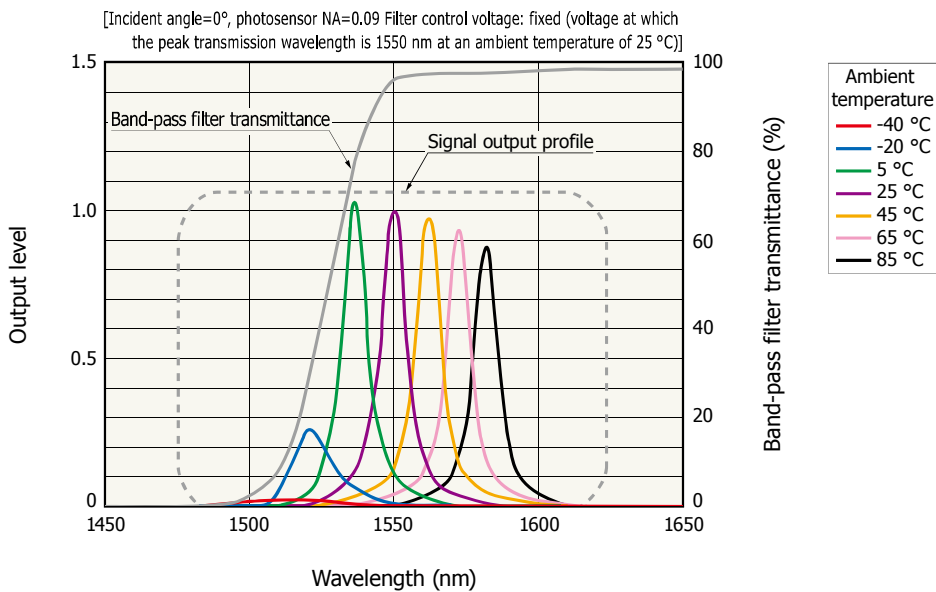

KACCB0445EB

(c) C14273

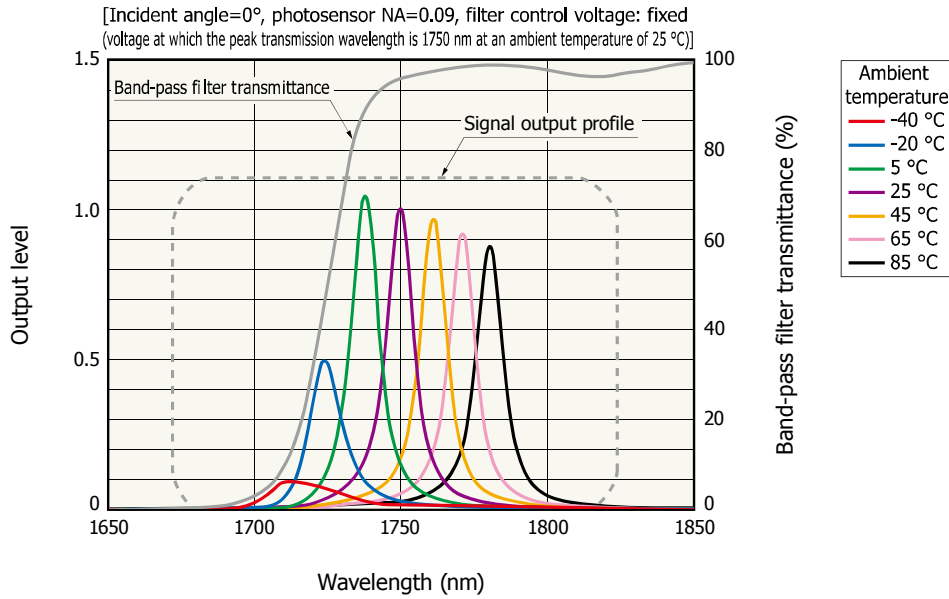

KACCB0521EA

Peak transmission wavelength detection with high accuracy is to be possible with little influence from a band-pass filter by compensation of filter control voltage to ambient temperature, which is within an operating temperature range (-40 to +85 °C) and a spectral response range. A relation between filter control voltage and ambient temperature is shown in Figure 3-12. Filter control voltage shifts [calculated with Figure 3-12 data and equation (3-19)] at the temperature changes [low temperature side (-40→+25 °C) and high temperature side (+25→+85 °C)] are shown in Figure 3-13. A filter control voltage shift becomes smaller at a shorter peak transmission wavelength, and that at a low temperature side is greater than that at a high temperature side. Close attention should be paid to the pull-in phenomenon particularly at a short wavelength range or at low temperature.

[Figure 3-12] Filter control voltage vs. ambient temperature (typical example)  
(a) C14272

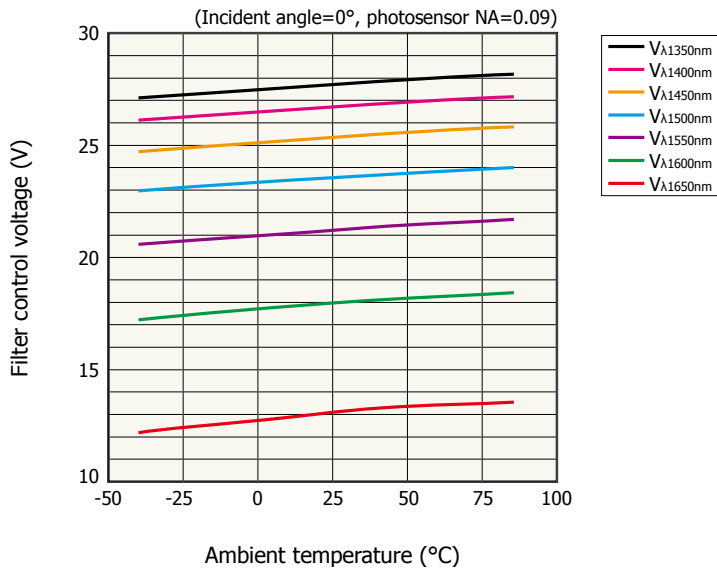

KACCB0475EA

(b) C13272-02

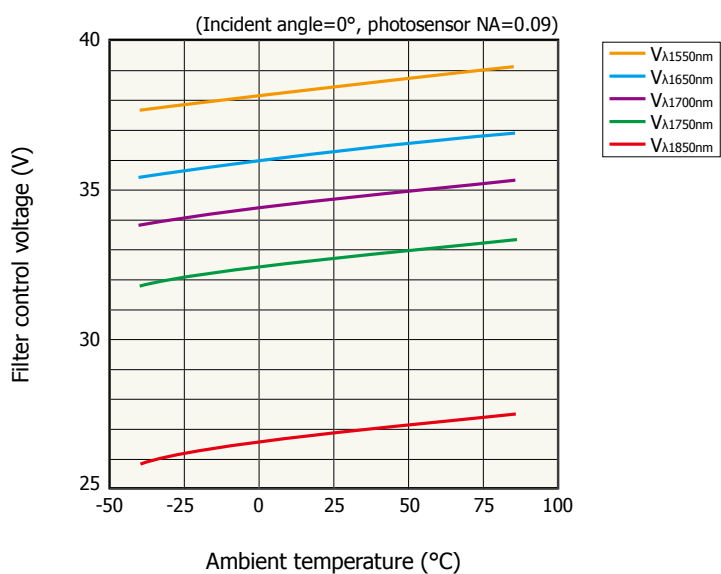

KACCB0432EB

(c) C14273

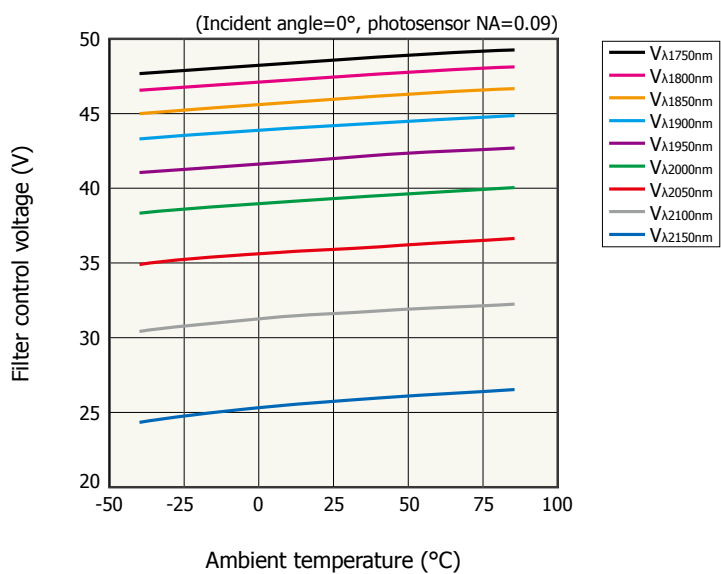

KACCB0506EA

[Figure 3-13] Filter control voltage shift vs. peak transmission wavelength (typical example)  
 (a) C14272

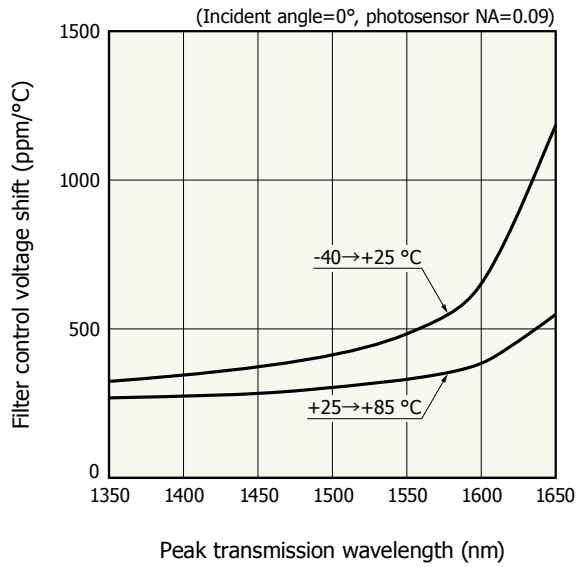

(b) C13272-02

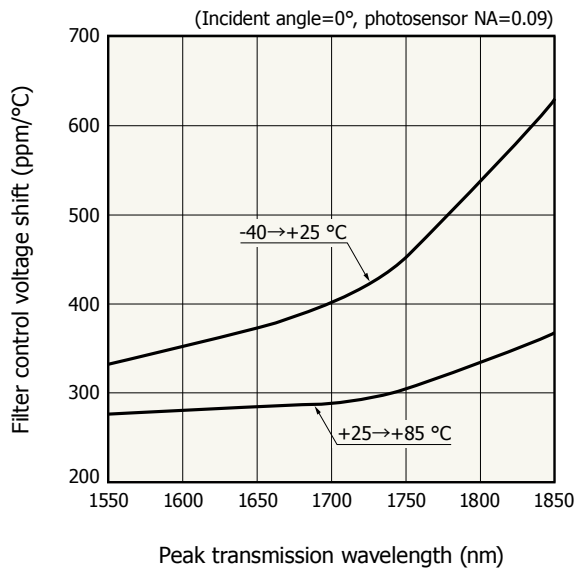

(c) C14273

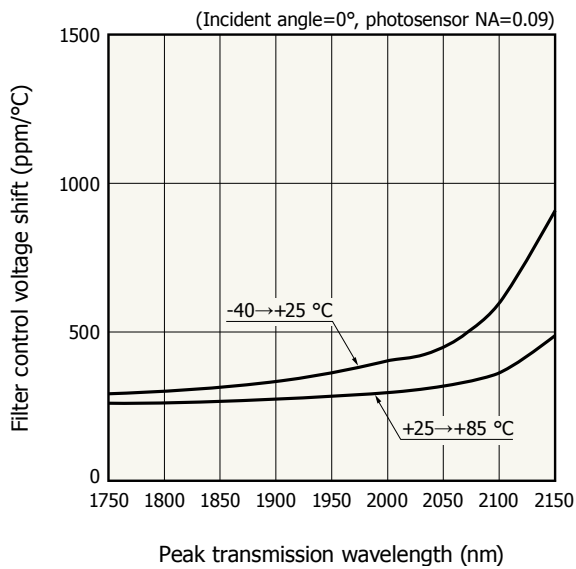

How to calculate filter control voltage shift is shown in equation (3-19).

$$\text{Filter control voltage shift} = \frac{(V - V_0)}{(T - T_0)V_0} \times 10^6 [\text{ppm}/^\circ\text{C}] \cdot \cdot \cdot (3-19)$$

T: ambient temperature

T<sub>0</sub>: ambient temperature (25 °C)

V: filter control voltage

V<sub>0</sub>: filter control voltage (25 °C)

### 3-7 Thermistor characteristics

A relation between thermistor resistance and temperature is shown in Figure 3-14.

[Figure 3-14] Thermistor resistance vs. temperature (typical example)

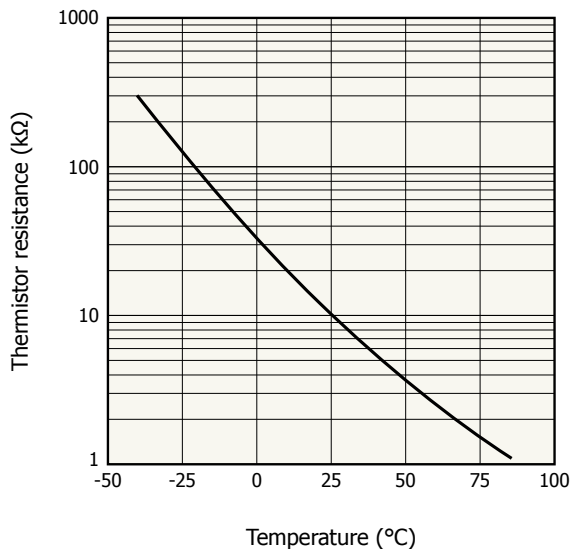

A value of thermistor resistance can be converted into temperature by using Steinhart-Hart equation (3-20).



$$1/T = A + B[\ln(R)] + C[\ln(R)]^3 \cdot \cdot \cdot (3-20)$$

T: temperature [K]

R: thermistor resistance ( $\Omega$ )

The precision of conversion can be improved by estimating the constants A, B and C of equation (3-20) with limiting a range of resistance values. An example is shown in Table 3-3 for reference.

[Table 3-3] Constants of Steinhart-Hart equation (reference example)

	A	B	C
(300.3) to 96.1	$3.53348 \times 10^{-3}$	$-7.87463 \times 10^{-5}$	$8.74259 \times 10^{-7}$
96.1 to 32.9	$1.46516 \times 10^{-3}$	$1.85960 \times 10^{-4}$	$2.32844 \times 10^{-7}$
32.9 to 5.3	$1.09316 \times 10^{-3}$	$2.40113 \times 10^{-4}$	$6.28813 \times 10^{-8}$
5.3 to (1.1)	$1.05955 \times 10^{-3}$	$2.44870 \times 10^{-4}$	$5.14556 \times 10^{-8}$

A value of thermistor resistance is converted into temperature by using equation (3-3) on the C13294-02 evaluation circuit for MEMS-FPI spectrum sensor (sold separately).

The following is an example of temperature measurement using thermistor resistance. Figure 3-15 shows the difference between the measured ambient temperature and the temperature calculated by dividing -20 to +85 °C into three temperature ranges, and calculating the constants A, B, and C by measuring each 30 samples.

[Figure 3-15] Difference in temperature between actual measurement and conversion from thermistor resistance values (measurement example, number of samples: 30)

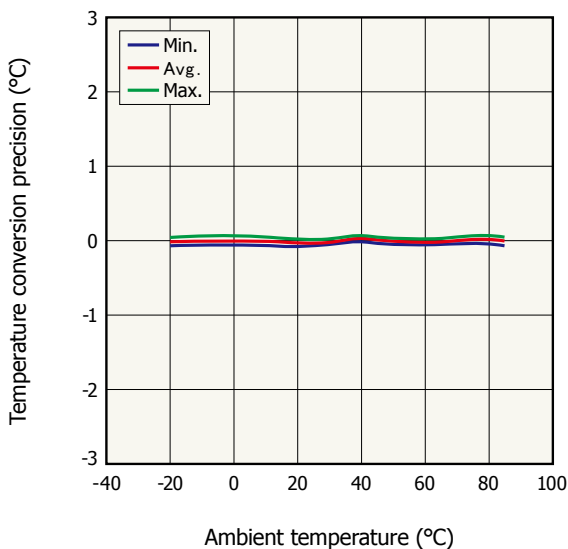

KACCB0523EA

An example of a certain tendency coming from a common lot, etc is hereby shown. For 30 samples, the constants A, B, and C are determined over three temperature ranges, and average values (A', B', and C') of the 30 samples are estimated. The differences between the measured value and the temperature calculated from the constants A', B', and C' are shown in Figure 3-16. This is inferior to performing temperature conversion individually on the accuracy, but it enables calibration in a short time.

[Figure 3-16] Difference in temperature between actual measurement and conversion from thermistor resistance values (measurement example, calculated from an average constant, number of samples: 30)

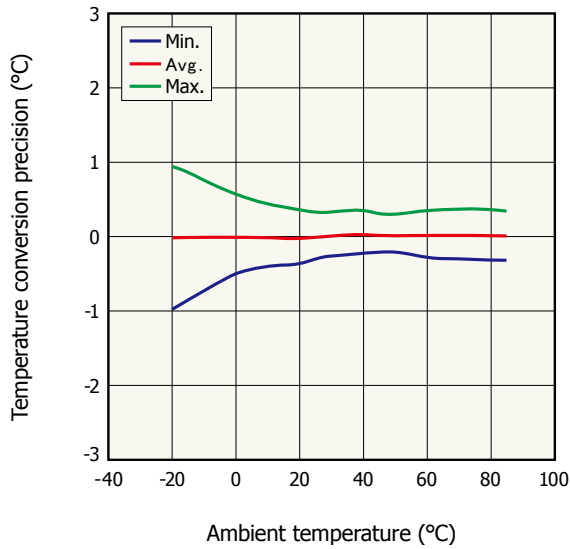

KACCB0524EA

### 3-8 Transmittance of MEMS-FPI tunable filter

The transmittance characteristic of a MEMS-FPI tunable filter is shown in Figure 3-17. The transmittance peak over a spectral response range is more than 50%. It is noted its characteristic differs from unit to unit.

[Figure 3-17] Transmittance of MEMS-FPI tunable filter vs. wavelength (typical example)  
(a) C14272

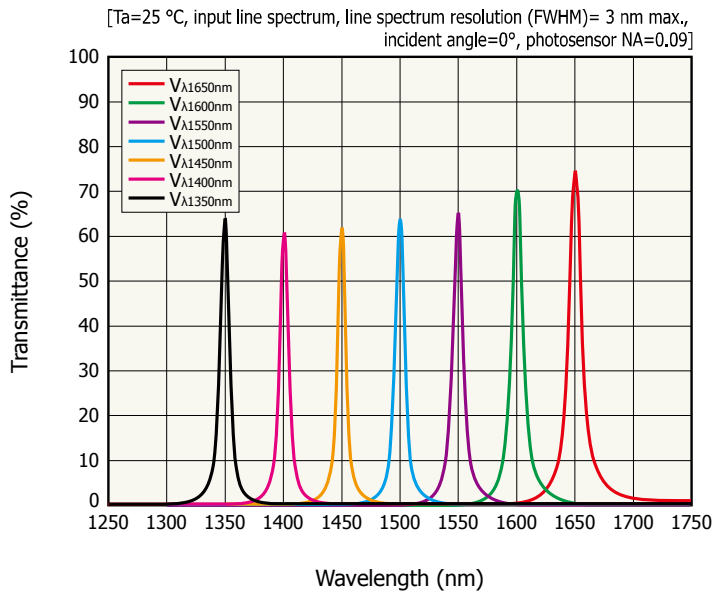

KACCB0477EA

(b) C13272-02

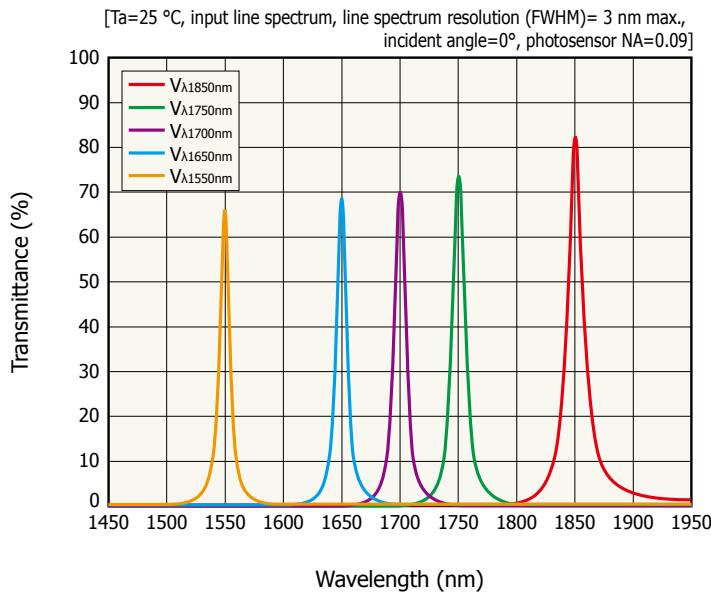

KACCB0405EA

(c) C14273

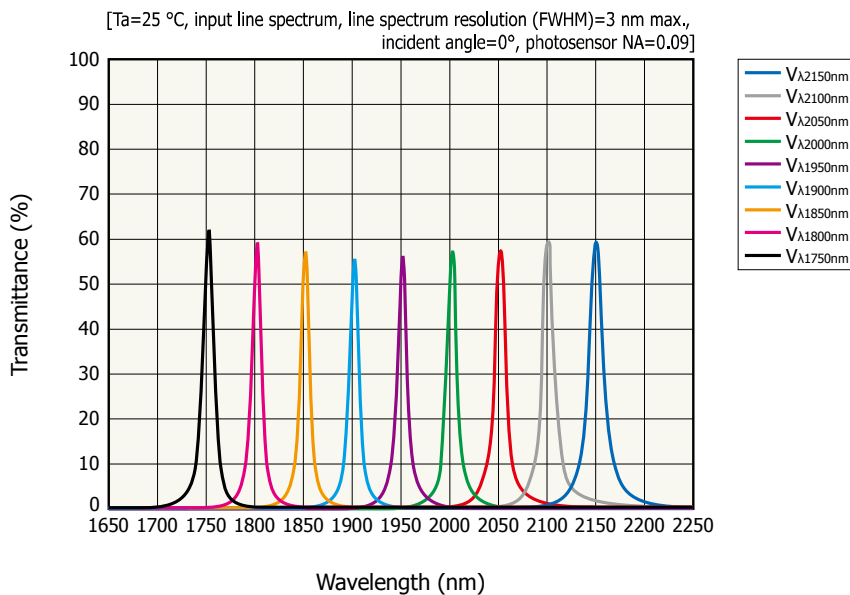

KACCB0508EA

### 3-9 Incident light aperture angle

Incident light aperture angle should affect the characteristics of a MEMS-FPI spectrum sensor. Figure 3-18 shows how peak transmission wavelengths are affected by the incident light aperture angle, and the how it influences wavelength resolution is indicated in Figure 3-19. As the angle of aperture is widened, the peak transmission wavelengths are shifted to a shorter wavelength side, and the wavelength resolution becomes coarser. Therefore, the incident light aperture angle should be made as small as possible (photosensor  $NA \leq 0.09$ , recommended), and also input to the MEMS-FPI spectrum sensor should be as vertically as possible (incident angle=0°).

The conditions of photosensor  $NA=0.09$  and incident angle=0° are set on the pre-shipping test of the MEMS-FPI spectrum sensors.

[Figure 3-18] Peak transmission wavelength vs. photosensor NA, incident light aperture angle (typical example)  
 (a) C14272

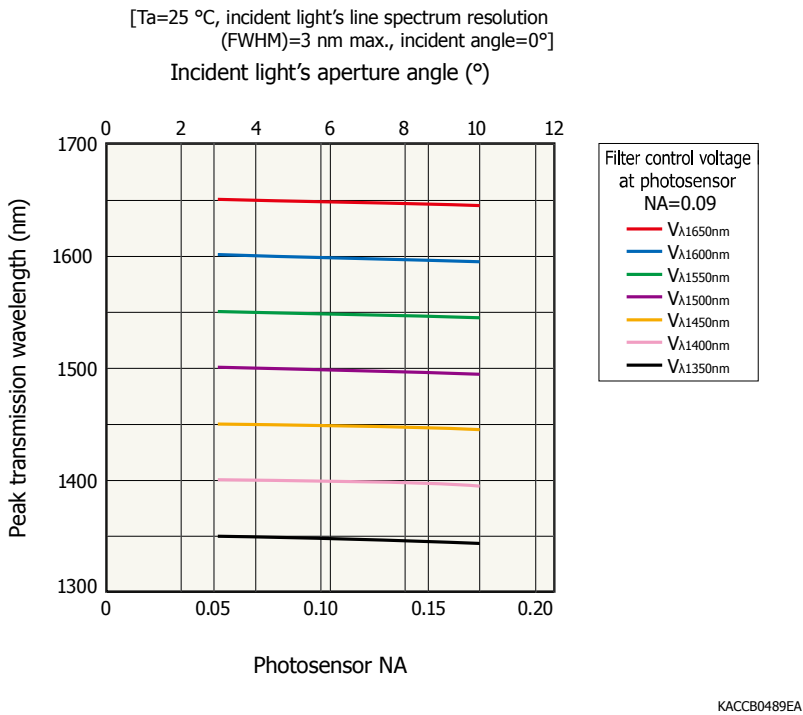

(b) C13272-02

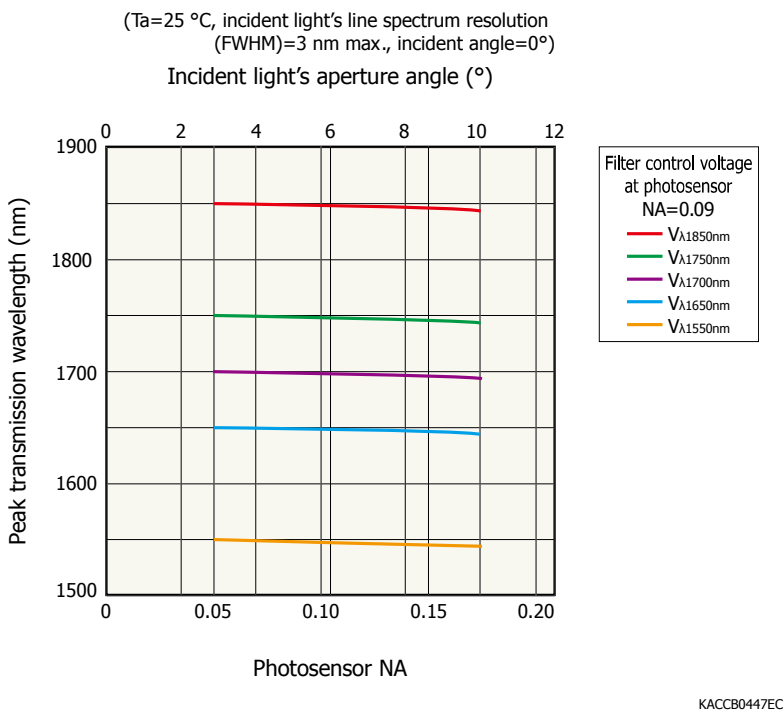

(c) C14273

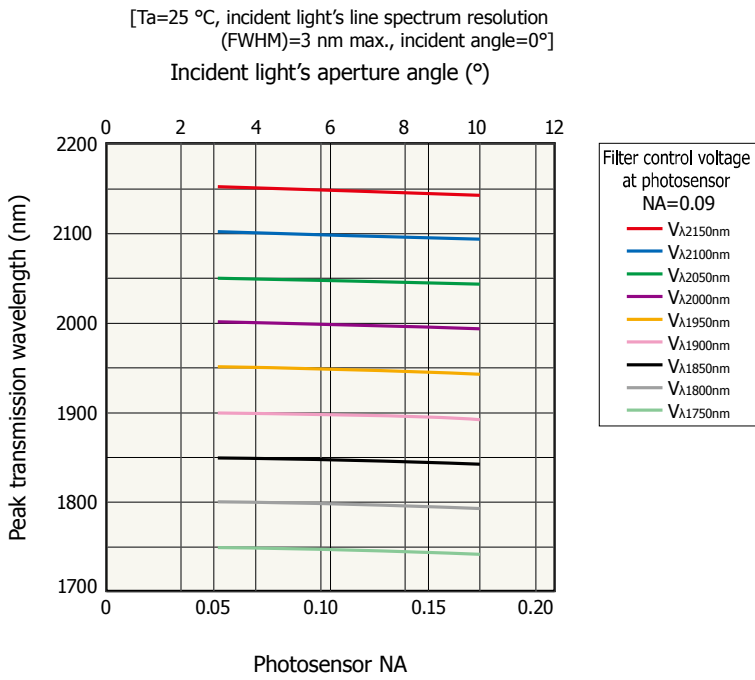

KACCB0525EA

[Figure 3-19] Spectral resolution vs. photosensor NA, incident light aperture angle (typical example)  
 (a) C14272

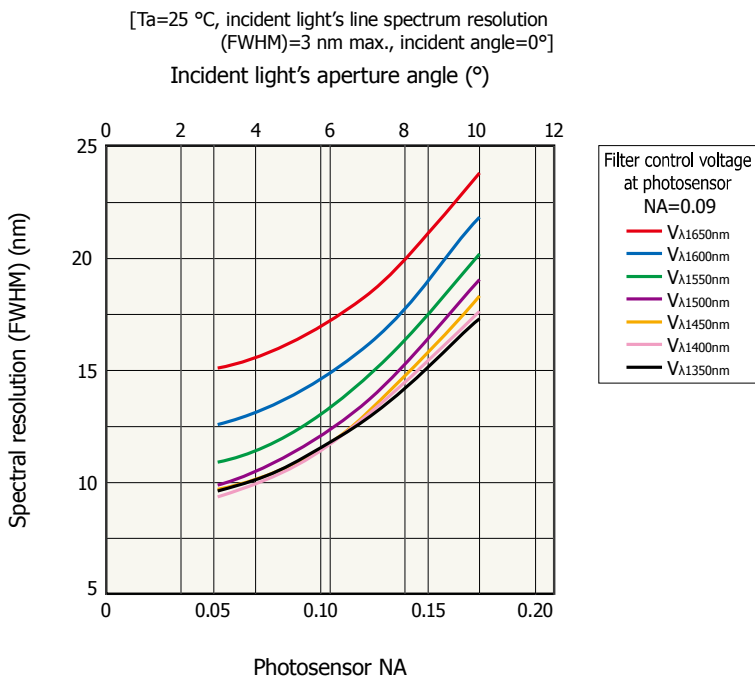

KACCB0490EA

(b) C13272-02

[Ta=25 °C, incident light's line spectrum resolution (FWHM)=3 nm max., incident angle=0°]  
 Incident light's aperture angle (°)

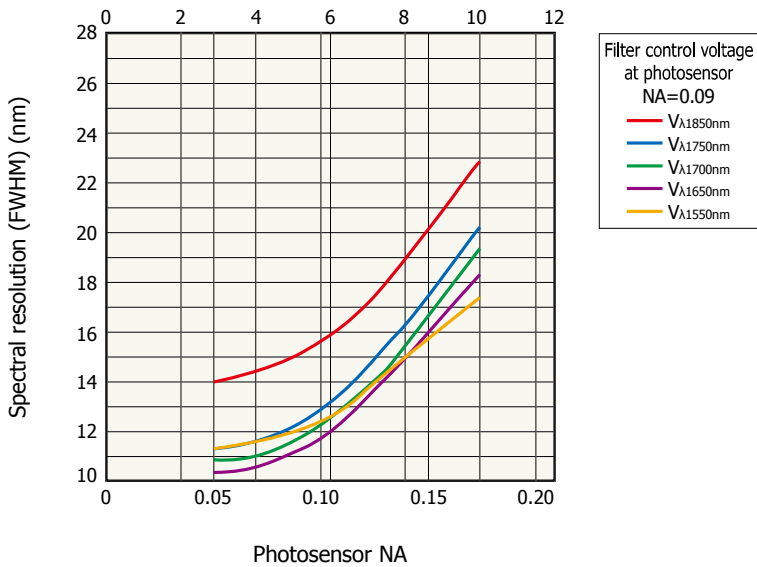

KACCB0448EC

(c) C14273

[Ta=25 °C, incident light's line spectrum resolution (FWHM)=3 nm max., incident angle=0°]  
 Incident light's aperture angle (°)

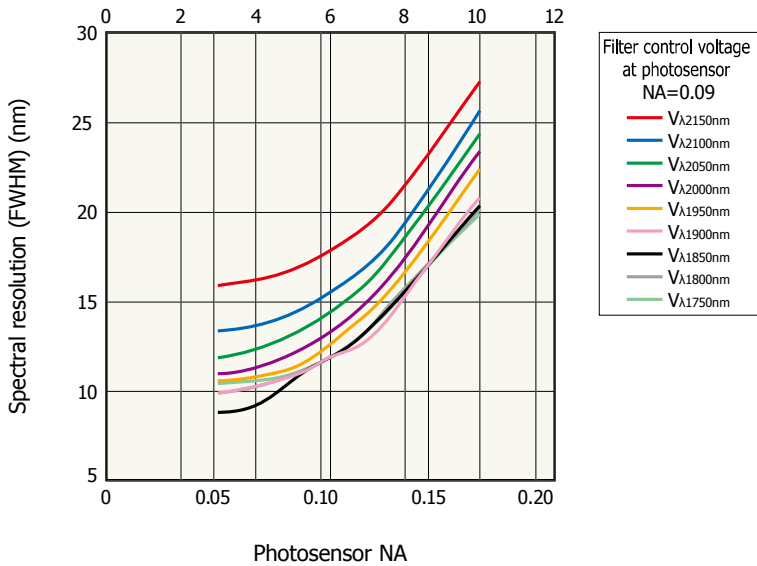

KACCB0526EA

3-10 InGaAs PIN photodiodes

MEMS-FPI spectrum sensors have a Hamamatsu InGaAs PIN photodiode built in as a photosensor. Figure 3-20 shows the spectral response characteristics of the built-in InGaAs PIN photodiode.

[Figure 3-20] Spectral response of built-in InGaAs PIN photodiode (typical example)

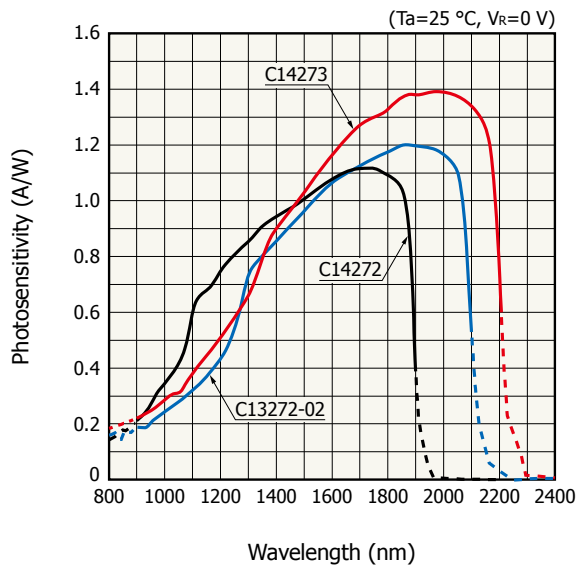

KIRDB0634ED

## 4. How to use

### 4-1 Connection example

An example of connection to a MEMS-FPI spectrum sensor is shown in Figure 4-1, and that of equipment used there is in Table 4-1.

[Figure 4-1] Connection example

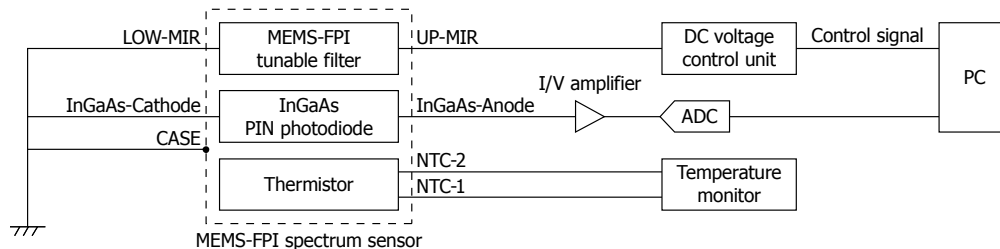

KACCC0804EA

[Table 4-1] Equipment example used in connection example [Figure 4-1]

DC voltage control unit*	6156	ADC Corporation
I/V amplifier	C4159-03	Hamamatsu Photonics

\* Two units in series connection

### 4-2 Evaluation circuit

The C13294-02 is a circuit board designed to simply evaluate the MEMS-FPI spectral sensor. By connecting the circuit board to a PC (sold separately) with a USB cable (A-micro B type) and using the accompanying evaluation software, you can evaluate the characteristics of the MEMS-FPI spectrum sensor.

[Figure 4-2] Block diagram (C13294-02)

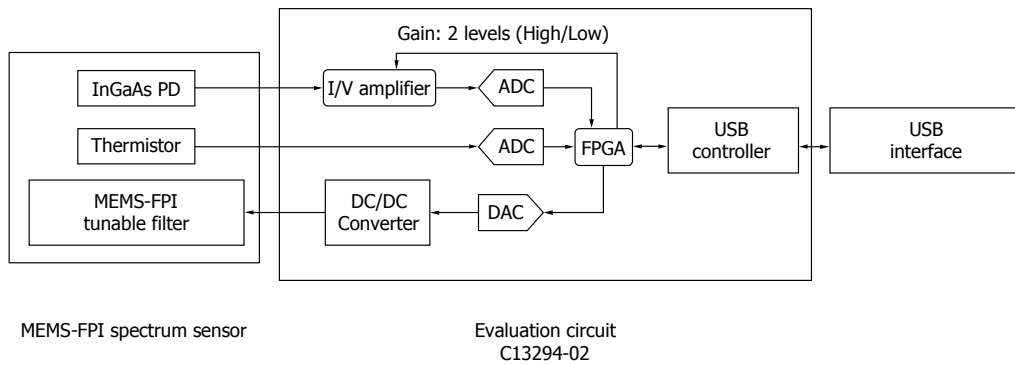

MEMS-FPI spectrum sensor

Evaluation circuit  
C13294-02

KACCC0845EB

The procedure for using the evaluation circuit C13294-02 should be referred to section 5. Q&A, [Q10](#).

### 4-3 Example of evaluation system

- On use of monochromator

An example of MEMS-FPI spectrum sensor evaluation system is shown in Figure 4-3. White light emitted by a halogen lamp, etc. is converted into single wavelength light by a monochromator, which is guided to a lens through an optical fiber, and then illuminated to the MEMS-FPI spectrum sensor. Signal from the sensor is outputted via an amplifier. A wavelength profile at a fixed air gap can be obtained by scanning the monochromator's wavelengths with fixing the MEMS-FPI spectrum sensor's filter control voltage. Subsequently, plural spectrums can be obtained by acquiring the data in the same way with varying the filter control voltage.

[Figure 4-3] Example of evaluation system (monochromatic light from monochromator)

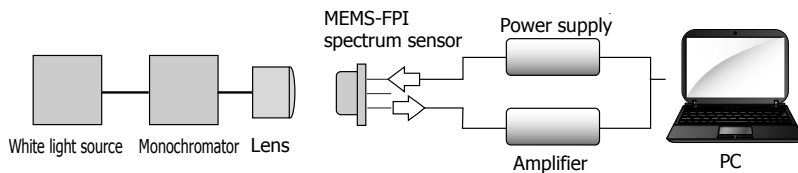

KACCC0846EA

An example of MEMS-FPI spectrum sensor C13272-02 evaluation result is shown in Figure 4-4. A wavelength profile at each filter control voltage is defined by the maximum value of output at  $\lambda_{1550\text{nm}}$ . The output value is related to the measurement system, the transmittance characteristics of the MEMS-FPI tunable filter, and the spectral response characteristics of the photosensor.

Wavelength resolution can be calculated by estimating FWHM (full width half maximum) with Gauss fitting the wavelength profile. As shown in Figure 3-5, the wavelength resolution over a spectral response range (1550 to 1850 nm) is 20 nm or smaller.



[Figure 4-4] Wavelength profile (C13272-02, typical example)

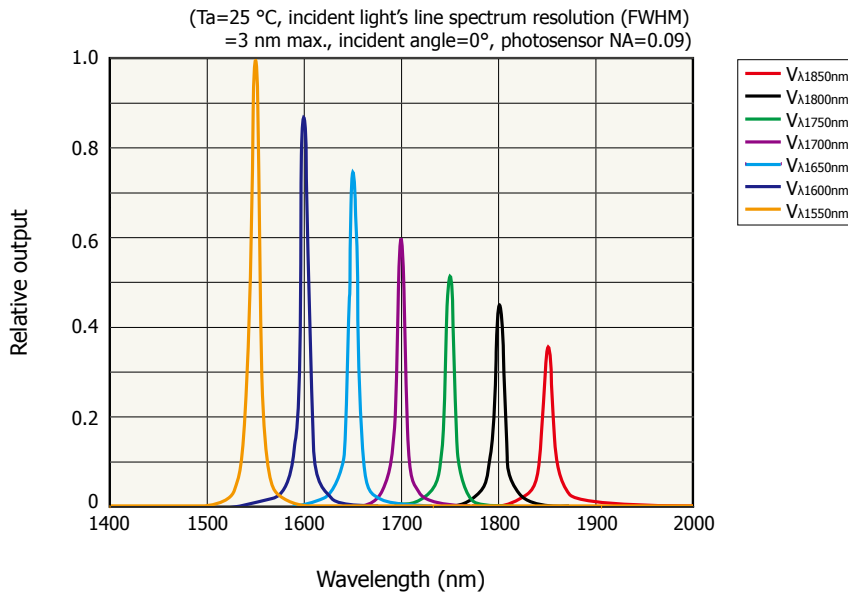

KACCB0449EA

- On no use of monochromator

A system for evaluating a MEMS-FPI spectrum sensor can be formed even without using a monochromator.

[Figure 4-5] Example of evaluation system (white light source)

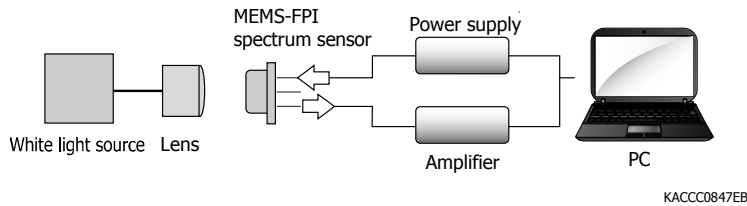

KACCC0847EB

## 4-4 Applications

A setup example of an absorbance measurement with using the MEMS-FPI spectrum sensor is shown in Figure 4-6. Solution or solid body can be discriminated by this configuration. Transmission light intensity ( $I$ ) at a single wavelength in particular is to be obtained by illuminating light transmitted through a measurement cell to a MEMS-FPI spectrum sensor. Assuming no sample in the measurement cell to be reference (intensity  $I_0$ ), an approximate value of the absorbance ( $A$ ) at a single wavelength can be estimated by equation (4-1).

$$A = -\log_{10} \left( \frac{I}{I_0} \right) \quad \dots (4-1)$$

Unlike a dispersive type spectrometer, the MEMS-FPI spectrum sensor has rather large stray light, and is not designed for a precision measurement. It is suited to see genuineness or spuriousness of a material, simpler checker, etc. by detecting peak wavelength points for example, rather than quantitative measurements.

[Figure 4-6] Absorbance measurement setup example using MEMS-FPI spectrum sensor

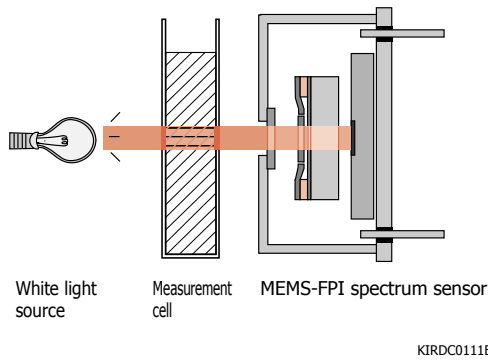

The MEMS-FPI spectrum sensor is very compact, which is expected to be built in a small device or connected with a mobile terminal. An image of use in a compact module with a smart phone is shown in Figure 4-7.

[Figure 4-7] Image of use in compact module

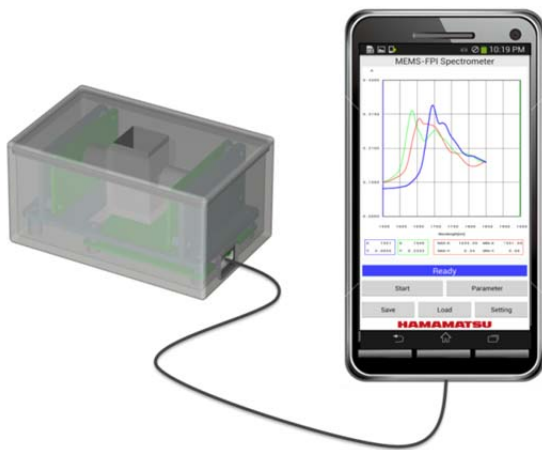

## 5. Q&A

**Q1** What are main features of the MEMS-FPI spectrum sensor in comparison with the dispersive-type spectrometer?

The MEMS-FPI spectrum sensor is not so superior in characteristics like a spectral response range and spectral resolution as the dispersive-type spectrometer. Low cost is realized by utilizing a single channel photodiode on the MEMS-FPI spectrum sensor, whereas an image sensor is used in the dispersive-type spectrometer. In addition to its compactness, an optical fiber is not necessary for input, which is to allow it to be built in a detection system easily.

[Table 5-1] Comparison between MEMS-FPI spectrum sensor and Mini-spectrometer

Parameter	MEMS-FPI spectrum sensor			Mini-spectrometer (G9914GB)
	C14272	C13272-02	C14273	
Spectral response range	1.35 to 1.65 $\mu\text{m}$	1.55 to 1.85 $\mu\text{m}$	1.75 to 2.15 $\mu\text{m}$	1.1 to 2.2 $\mu\text{m}$
Spectral resolution (FWHM)	18 nm	20 nm	22 nm	8 nm
Compactness	◎			○
Price	◎			○

**Q2** Does the spectral resolution of the MEMS-FPI spectrum sensor vary with the transmission wavelength ?  
 Yes, the spectral resolution varies with the transmission wavelength. A typical example is shown in the Figure 3-3.

**Q3** Are there any particular cautions needed to prevent a MEMS-FPI tunable filter from damage?

Be sure to keep the filter control voltage from exceeding the absolute maximum rating. If this value is exceeded, the MEMS-FPI tunable filter will break. Note that the absolute maximum rating of the filter control voltage varies by product and change depending on the temperature.

As a typical example, the temperature characteristics of  $V_{\lambda 1550\text{nm}}$  (filter control voltage for transmitting light with  $\lambda=1550\text{ nm}$ ) on the C13272-02 are shown in Figure 5-1. The absolute maximum rating of the C13272-02 filter control voltage is  $V_{\lambda 1550\text{nm}} + 0.5\text{ V}$ . This indicates that adding 0.5 V or more to  $V_{\lambda 1550\text{nm}}$  at a given temperature may damage the MEMS-FPI tunable filter.

[Figure 5-1] Temperature characteristics of  $V_{\lambda 1550\text{nm}}$  (C13272-02, typical example)

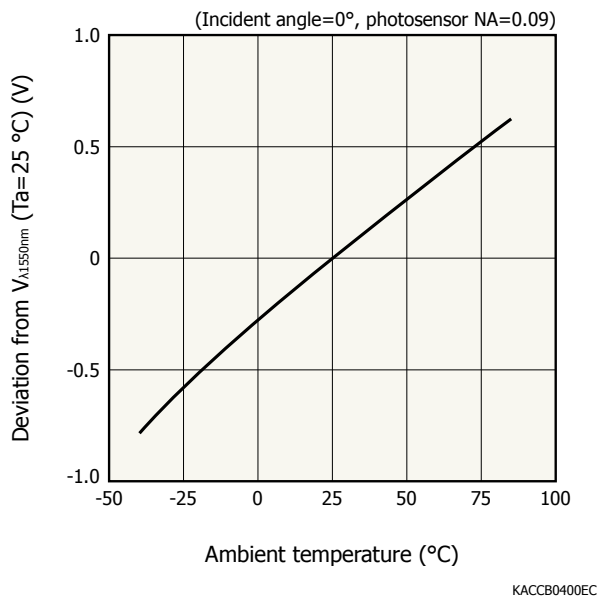

Use of the software attached with the evaluation circuit C13294-02 should relieve such a risk. The sensor calibration coefficient attached with a sensor should be inputted on the software. It is noted that the sensor calibration coefficient provided are from our measurement at room temperature ( $T_a=25\text{ °C}$ ). Due countermeasures against electrostatic discharge should be taken by referring to the instruction manual as a photodiode built in the MEMS-FPI spectrum sensor is very weak to the static electricity. The details about electrostatic discharge resistance should be referred to datasheets or an instruction manual.

**Q4** How does the ambient temperature affect the MEMS-FPI spectrum sensor's characteristics?

The MEMS-FPI spectrum sensor has a temperature characteristic, so there is a characteristic change with the temperature. An example of the C13272 series temperature characteristic is shown in the Figure 3-9 and 3-12. It is possible to compensate the temperature using a calculation formula (3-2 Filter control voltage and peak transmission wavelength / Compensation of temperature characteristics of filter control voltage and peak transmission wavelength). Due compensation should be done by a user as necessary for improving the measurement accuracy.

**Q5** What is a relation between MEMS-FPI tunable filter's transmission wavelength and filter control voltage?

High reflection upper and lower mirrors of the MEMS-FPI tunable filter are faced each other via an air gap, and the transmission wavelength is to be varied by tuning the gap with the filter control voltage. The transmission wavelength gets shorter by narrowing the air gap with filter control voltage increase. There are some individual differences on the mirrors and the air gap, so a relation between the peak transmission wavelength and the filter control voltage differs from unit to unit. Therefore, the inspection data showing the filter control voltages ( $T_a=25\text{ °C}$ ) for the minimum and maximum values within the spectral response range is to be attached with a product to deliver. The reference data of four constants (sensor calibration coefficient) for calculating the relationship between the transmission wavelength and the filter control voltage is also to be added. It is noted these data provided are from our own measurement conditions, so no guarantee on a user's operating environments (optical environments, temperature, etc.) are given. For enhancing the measurement accuracy, calibration on a user's own operating conditions may be required. Furthermore, the filter control voltage has to be tuned at the absolute maximum rating or less.

---

**Q6** What should be prepared for evaluating the MEMS-FPI spectrum sensor?

The evaluation circuit C13294-02 (sold separately) is to be prepared for evaluating the MEMS-FPI spectrum sensor. In addition, a light source (e.g., a white light source like halogen) should be prepared.

**Q7** Could you suggest a suitable light source?

A suitable light source should differ with measurement methods (e.g., reflection, transmission), measurement objects, etc. In general, a white light source like halogen is suggested. A near infrared LED (L10660 series by Hamamatsu, 1450 nm in peak emission wavelength, 120 nm in FWHM or L12509 series, 1550 nm in peak emission wavelength, 120 nm in FWHM) may be appropriate on some applications. However, near infrared LEDs cannot emit light over the entire spectral response range of the MEMS-FPI spectrum sensor.

**Q8** How can measurement time be shortened?

3 to 12 seconds are total measurement time on default when the MEMS-FPI spectrum sensor is operated with the evaluation circuit C13294-02 (sold separately) in general. The measurement time by the MEMS-FPI spectrum sensor itself is about 2 seconds. Additional times for data processing, data transfer and PC response are to be needed also, which is to make the total measurement time of 3 to 12 seconds. The measurement time can be shortened by enlarging a wavelength pitch (=reducing measurement points), and it can be reduced to 1 to 3 seconds on the wavelength pitch of 10 nm. Furthermore, an actual measurement time depends upon the performances of the PC, and a longer time than one herein measurement might be required.

Note: Default settings of the evaluation software

The default settings vary depending on the selected calibration data (varies by sensor type no.).

[C14272]

- Spectral response range: 1350 to 1650 nm
- Measurement wavelength pitch: 1 nm
- Averaging count: 128

[C13272-02]

- Spectral response range: 1550 to 1850 nm
- Measurement wavelength pitch: 1 nm
- Averaging count: 128

[C14273]

- Spectral response range: 1750 to 2150 nm
- Measurement wavelength pitch: 1 nm
- Averaging count: 128

**Q9** Can the evaluation circuit C13294-02 realize selective measurement by arbitrary points?

The evaluation circuit C13294-02 does not have such a function. This operation should be realized by newly designing a circuit and software at a user's side. So that the user can select the measurement point, reference examples of the response time (when using the C13272-02) on a step operation by varying the filter control voltage are herein shown.

<Reference values>

1 step for 300 nm range (e.g., 1550 nm to 1850 nm)

→ 1 ms typ. in settling time (99%)

4 steps for 5 nm range (e.g., 1550 nm to 1555 nm, 1645 nm to 1650 nm, 1745 nm to 1750 nm, 1845 nm to 1850 nm)

→ 0.2 ms typ. in settling time (99%) at each step

The settling time must also be considered when using other MEMS-FPI spectrum sensors. The measurement time on an actual use greatly depends upon the circuit and the software to be designed by a user.

**Q10** How can the evaluation circuit C13294-02 be operated ?

The flow of a measurement using the evaluation circuit C13294-02 (software attached) is herein explained.

① Dark measurement

The dark data from a MEMS-FPI spectrum sensor in a dark state with a specified wavelength range is to be

acquired (incidence of the light to a sensor should be interrupted). This dark data is to be subtracted from the sample measurement data at a later step.

[Figure 5-2] Dark measurement

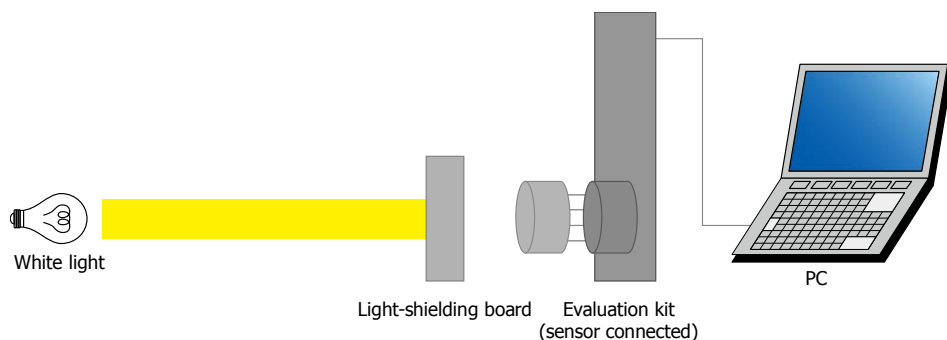

KACCC0826EB

### ② Reference measurement

The reference data from a MEMS-FPI spectrum sensor with light input within a specified wavelength range is to be acquired.

[Figure 5-3] Reference measurement

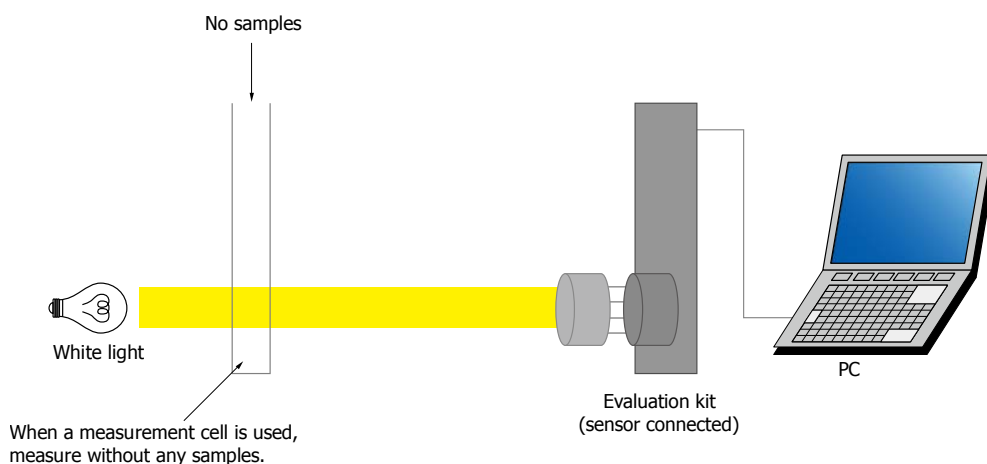

KACCC0827EB

### ③ Sample measurement

The sample data from a MEMS-FPI spectrum sensor while a sample is placed between a light source and the sensor within a specified wavelength range is to be acquired. On a multi-sample measurement, the sample measurement is to be repeated in the same way for the number of settings.

[Figure 5-4] Sample measurement

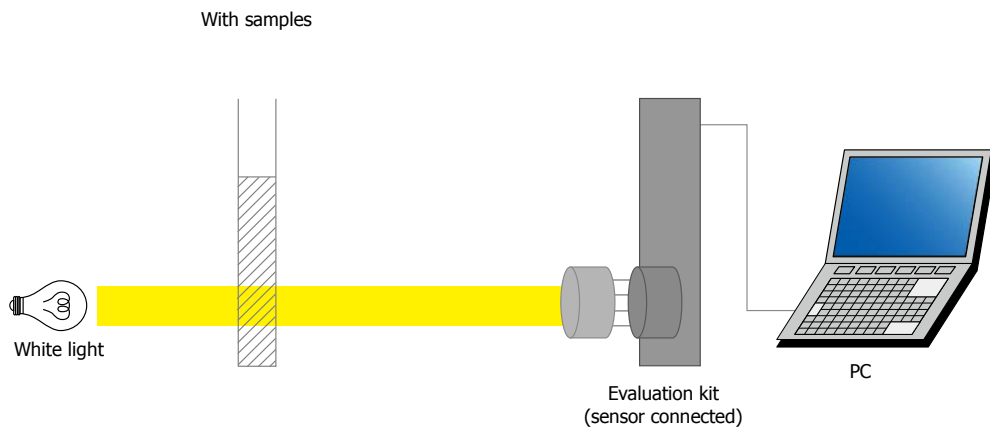

KACCC0828EB

④ Graph output

The output of transmission or absorbance can be obtained by a graph [A/D counts (PD output amplified by an amp) being possible to obtain], and the acquired data can be stored in the CSV format.

**Q11** Is DLL for the evaluation circuit C13294-02 available?

The DLL is not supplied. The evaluation circuit C13294-02 is just for an evaluation purpose, and not for being built in a measuring system.

**Q12** Are there measurement examples of the MEMS-FPI spectrum sensor available?

A result of the plastic measurement is shown as an example.

<Measurement conditions>

MEMS-FPI spectrum sensor C13272-02, evaluation circuit C13294-02, tungsten lamp, measurement wavelength pitch: 1 nm, averaging count: 128, gain: low

[Figure 5-5] Measurement example 1 (plastic: 4 types, thickness: 5 mm)

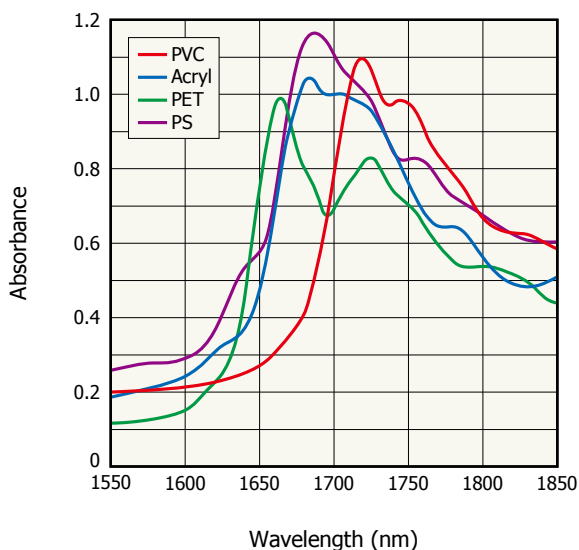

KACCB0491EB

[Figure 5-6] Measurement example 2 (plastic: acryl, thickness: 2 mm, 3 mm, 5 mm)

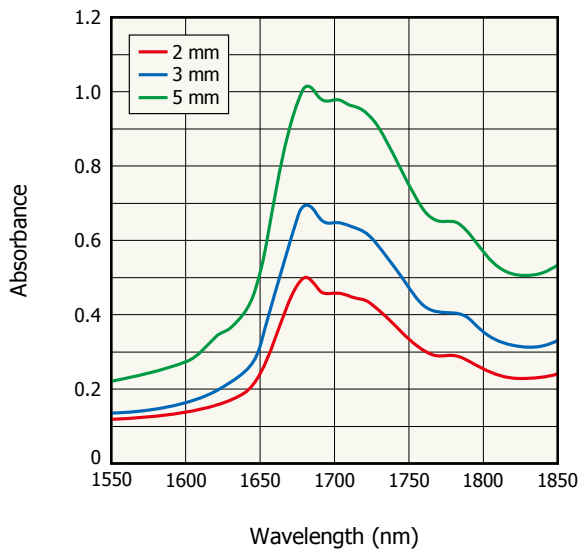

KACCB0492EB

**Q13** Do you have a plan to develop a large-area MEMS-FPI spectrum sensor?

We have no plan at this point. There are two types of the MEMS-FPI tunable filter, and each feature is summarized in Table 5-2. We are focusing on the advantages (low cost and low voltage operation) of an electro-static type, and are planning to develop a new product by utilizing these features.

[Table 5-2] Comparison between electro-static actuator and piezo-actuator methods (MEMS-FPI tunable filter)

Parameter	Electro-static actuator (Hamamatsu Photonics K.K.)	Piezo-actuator
Advantage	Low cost, low voltage operation	Suitable for large size
Disadvantage	Difficult for large size	High cost, high voltage operation

**Q14** Is it possible to manage the serial numbers with 2D codes when the MEMS-FPI spectrum sensor is used in mass-production equipment?

DataMatrix (2D code), the type number, the serial number and the lot number are to be marked on a top surface of a metal package, and the DataMatrix includes information on the type number and the serial number, so it should be utilized. The details about the marking information should be referred to the datasheet or the instruction manual.

**Q15** Is it possible to make a custom product to cover a new spectral response range?

We would like you to use the standard product as much as possible. If the wavelength ranges of our current lineup cannot cover your wishes, please consult with the Hamamatsu office. Customization is to be considered by learning the requirements (wavelength range, application, expected business scale, etc).

**Q16** Can the spectral response range be widened by about 300 to 400 nm?

The MEMS-FPI tunable filter uses the principle of a Fabry-Perot interferometer and cannot theoretically extend the spectral response range. When the air gap between the upper and lower mirrors is  $m\lambda/2$ , the  $n$ -th order light component relative to the detection wavelength also passes through the MEMS-FPI tunable filter, since it functions as a filter that transmits approximately the wavelength  $\lambda$  ( $m$ : integer). The  $n$ -th order light component is blocked from the outside of the package by the built-in band-pass filter.

**Q17** Are there any demo units available? The basic characteristics are needed to see before purchase.

Yes, a few demo units have been prepared, so consult with our sales representative, please.

**Q18** What are the contents of the final inspection sheet and reference datasheet attached to the MEMS-FPI spectrum sensor and what kind of data format are they in?

The final inspection sheet contains the following inspection items.

---

[C14272]

- Peak voltage ( $\lambda=1650$  nm)
- Peak voltage ( $\lambda=1350$  nm)
- Dark current ( $V_R=0.5$  V)
- Thermistor resistance

[C13272-02]

- Peak voltage ( $\lambda=1850$  nm)
- Peak voltage ( $\lambda=1550$  nm)
- Dark current ( $V_R=0.5$  V)
- Thermistor resistance

[C14273]

- Peak voltage ( $\lambda=2150$  nm)
- Peak voltage ( $\lambda=1750$  nm)
- Dark current ( $V_R=0.5$  V)
- Thermistor resistance

Measurement conditions are as follows: incident angle:  $0^\circ$ , photosensor NA: 0.09, incident light's line spectrum resolution (FWHM): 3 nm max., ambient temperature: 25 °C. The final inspection sheet is attached to the product as a paper document.

The reference datasheet contains the room temperature compensation constant and the temperature compensation constant (see section 3-2, "Filter control voltage and peak transmission wavelength") under the above measurement conditions for each serial number. A CD containing the reference datasheet (Microsoft Excel data) is attached to the product.